



825 Diligence Drive, Suite 205  
Newport News, Virginia 23606  
tel: 757 873-8850  
fax: 757 596-2694

March 7, 2005

Harry F. Bailey  
Environmental Engineer  
Public Water Supply Section  
Department of Environment and Natural Resources  
943 Washington Square Mall  
Washington, NC 27889

Subject: Well Completion Documents for Production Well No. 15  
Dare County Water System  
PWS ID 04-28-030, Dare County

Dear Mr. Bailey:

On behalf of Dare County Water, CDM is pleased to inform you that Dare County's Production Well No. 15 has been constructed and tested by A.C. Schultes of Carolina, Inc. Attached for your information and review are four sets of well completion documents that include the following information:

- Signed Well Drillers Log
- Well Yield and Drawdown Report
- TDH and Pump Head Calculations
- Engineer's Well Construction Verification
- Well Site Deed and Plat [**Pending. See Below**]
- Water Quality Analyses

The deed of easement between the State of North Carolina and Dare County has yet to be completed. Once it is executed, copies will be sent to you for insertion into the binders (under Section 5).

An Application for Approval of Engineering Plans and Specifications for this project was received by NCDENR on January 9, 2004 (Tracking No. 04-00061) and pulled for review on March 4, 2004. The referenced application included Production Wells Wilbur, Orville, 15, and 17. **We are requesting authorization to finish all construction associated with Production Well No. 15.**



Harry F. Bailey  
March 7, 2005  
Page 2

It is our professional opinion, based upon our review of the water quality and hydrogeologic characteristics of this new well, that the NCDENR should be able to authorize the construction of the permanent facility.

Thank you for your attention and assistance to this critical project for the County. If you have any questions or I can be of further assistance, please do not hesitate to call.

Sincerely,

A handwritten signature in black ink, appearing to read 'G. St. John', written over a circular stamp or mark.

Gary A. St. John, P.E., DEE  
Associate  
Camp Dresser & McKee Inc.

cc: Kenneth C. Flatt - Dare County Water  
W. Scott Manahan - CDM

# **Production Well #15**

## **Well Completion Data**

### **Table of Contents**

**Section 1: Signed Well Drillers Log**

**Section 2: Well Yield and Drawdown Report**

**Section 3: TDH and Pump Head Calculations**

**Section 4: Engineer's Well Construction Verification**

**Section 5: Well Site Deed/Plat**

**Section 6: Water Quality Analyses**

# WELL CONSTRUCTION RECORD

North Carolina - Department of Environment and Natural Resources - Division of Water Quality - Groundwater Section

WELL CONTRACTOR (INDIVIDUAL) NAME (print) Edward A. Jackson CERTIFICATION # 2426  
 WELL CONTRACTOR COMPANY NAME A.C. Schultes of Carolina, Inc. PHONE # (910) 285-7465  
 STATE WELL CONSTRUCTION PERMIT # WS0700769 ASSOCIATED WQ PERMIT # \_\_\_\_\_  
 (if applicable) (if applicable)

1 WELL USE (Check Applicable Box): Residential  Municipal/Public  Industrial  Agricultural   
 Monitoring  Recovery  Heat Pump Water Injection  Other  If Other, List Use \_\_\_\_\_

2 WELL LOCATION:  
 Nearest Town: Nags Head County Dare  
Hwy 158, Jockey Ridge State Park, Nags Head, NC  
 (Street Name, Numbers, Community, Subdivision, Lot No., Zip Code)

Topographic/Land setting  
 Ridge  Slope  Valley  Flat  
 (check appropriate box)

3 OWNER: Dare County Water Department  
 Address Mustain Drive  
 (Street or Route No.)  
Kill Devil Hills, NC  
 City or Town State Zip Code

Latitude/longitude of well location

(degrees/minutes/seconds)

Latitude/longitude source:  GPS  Topographic map  
 (check box)

Area code - Phone number

4 DATE DRILLED December 22, 2004

5 TOTAL DEPTH: 395 Feet

6 DOES WELL REPLACE EXISTING WELL? YES  NO

7 STATIC WATER LEVEL Below Top of Casing: 17 FT.  
 (Use "+" if Above Top of Casing)

8 TOP OF CASING IS 3 FT. Above Land Surface \*

\*Top of casing terminate at/or below land surface requires a variance in accordance with 15A NCAC 2C.0118.

YIELD (gpm): 600 METHOD OF TEST Pump

WATER ZONES (depth) 290-390

11 DISINFECTION: Type \_\_\_\_\_ Amount w/ail \_\_\_\_\_

12 CASING:		Depth	Diameter	Thickness or Weight/Ft.	Material
From	+3	To 100	Ft 20"	0.250	Steel
From	+3	To 290	Ft 12"	0.750	SDR 17 PVC
From	390	To 395	Ft 8"	0.322	316 L SS
From		To	Ft		
From		To	Ft		

13 GROUT:		Depth	Material	Method
From	0	To 270	Ft Neat Cement	Tremmie
From		To	Ft	

14 SCREEN:		Depth	Diameter	Slot Size	Material
From	290	To 390	Ft 8 in	0.030 in	316 L SS
From		To	Ft	in	
From		To	Ft	in	
From		To	Ft	in	

15 SAND/GRAVEL PACK:		Depth	Size	Material
From	270	To 395	Ft #2	Southern Products
From		To	Ft	

16 REMARKS: \_\_\_\_\_

DEPTH		DRILLING LOG
From	To	Formation Description
See Attached		

### LOCATION SKETCH

Show direction and distance in miles from at least two State Roads or County Roads. Include the road numbers and common road names.

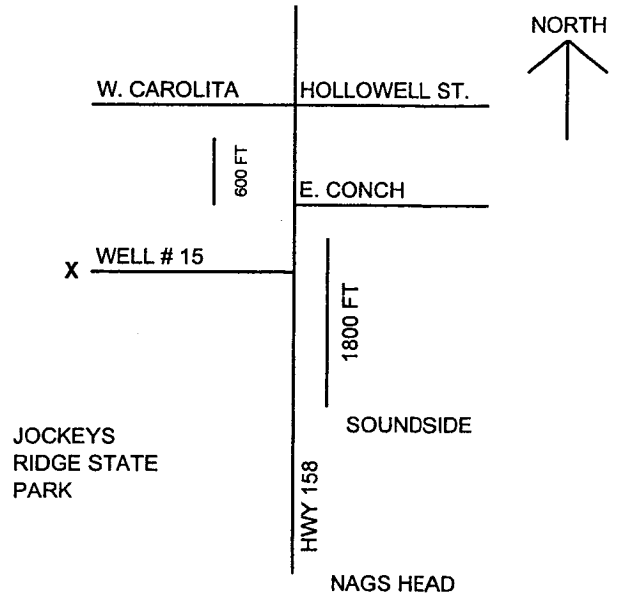

HEREBY CERTIFY THAT THIS WELL WAS CONSTRUCTED IN ACCORDANCE WITH 15A NCAC 2C, WELL CONSTRUCTION STANDARDS, AND THAT A COPY OF THIS RECORD HAS BEEN PROVIDED TO THE WELL OWNER

Edward A. Jackson  
 SIGNATURE OF PERSON CONSTRUCTING THE WELL  
 \_\_\_\_\_  
 DATE January 11, 2005

Submit the original to the Division of Water Quality, Groundwater Section, 1636 Mail Service Center - Raleigh, NC 27699-1636  
 Phone No. (919) 733-3221, within 30 days. GW-1 REV. 07/2001



# SAND ANALYSIS

## A.C. SCHULTES, INC.

Site Dare County #15 State North Carolina Date: 11/12/04  
 From Well of \_\_\_\_\_ #15  
 Remarks 280 - 290 Feet

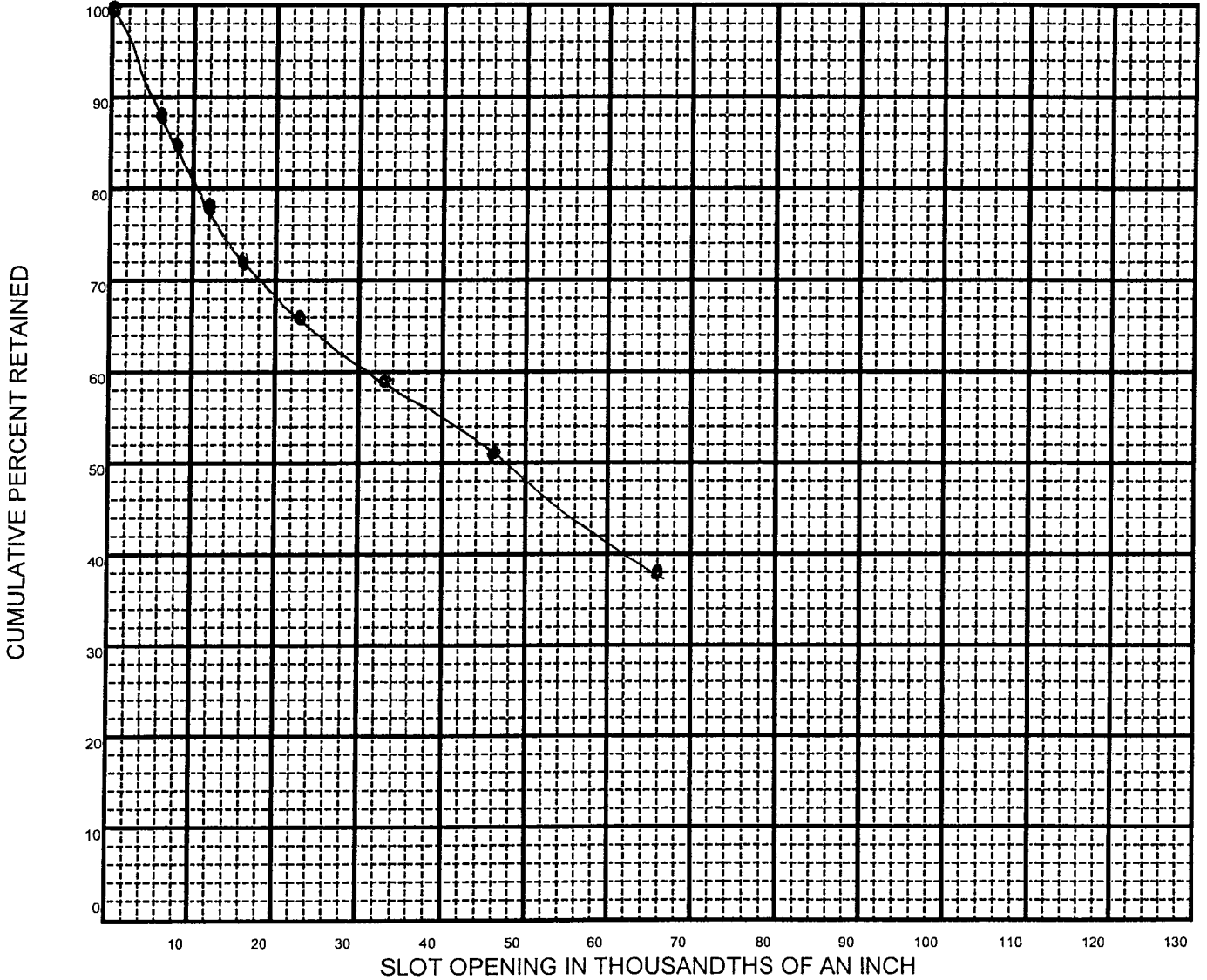

SIEVE OPENING	CUMULATIVE PERCENT RETAINED	
0.066	38	
0.046	51	
0.039		
0.033	59	
0.023	66	
0.016	72	
0.012	78	
0.008	85	
0.006	88	
PAN	100	
SCREEN SLOT		

NOTES: \_\_\_\_\_  
 \_\_\_\_\_  
 \_\_\_\_\_

SLOT OPENING RECOMMENDED: 0.030

RECOMMENDED SCREEN: DIA: \_\_\_\_\_ IN. LENGTH \_\_\_\_\_ FT.

BY: Randy Hudson

SO MANY CONSIDERATION ENTER INTO THE MAKING OF A GOOD WELL THAT WHILE WE BELIEVE SLOT SIZES FURNISHED OR RECOMMENDED FROM SAND SAMPLES ARE CORRECT WE ASSUME NO RESPONSIBILITY FOR THE SUCCESSFUL OPERATION OF JOHNSON WELL SCREENS

# SAND ANALYSIS

## A.C. SCHULTES, INC.

Site Dare County #15 State North Carolina Date: 11/12/04  
 From Well of \_\_\_\_\_ #15  
 Remarks 290 - 300 Feet

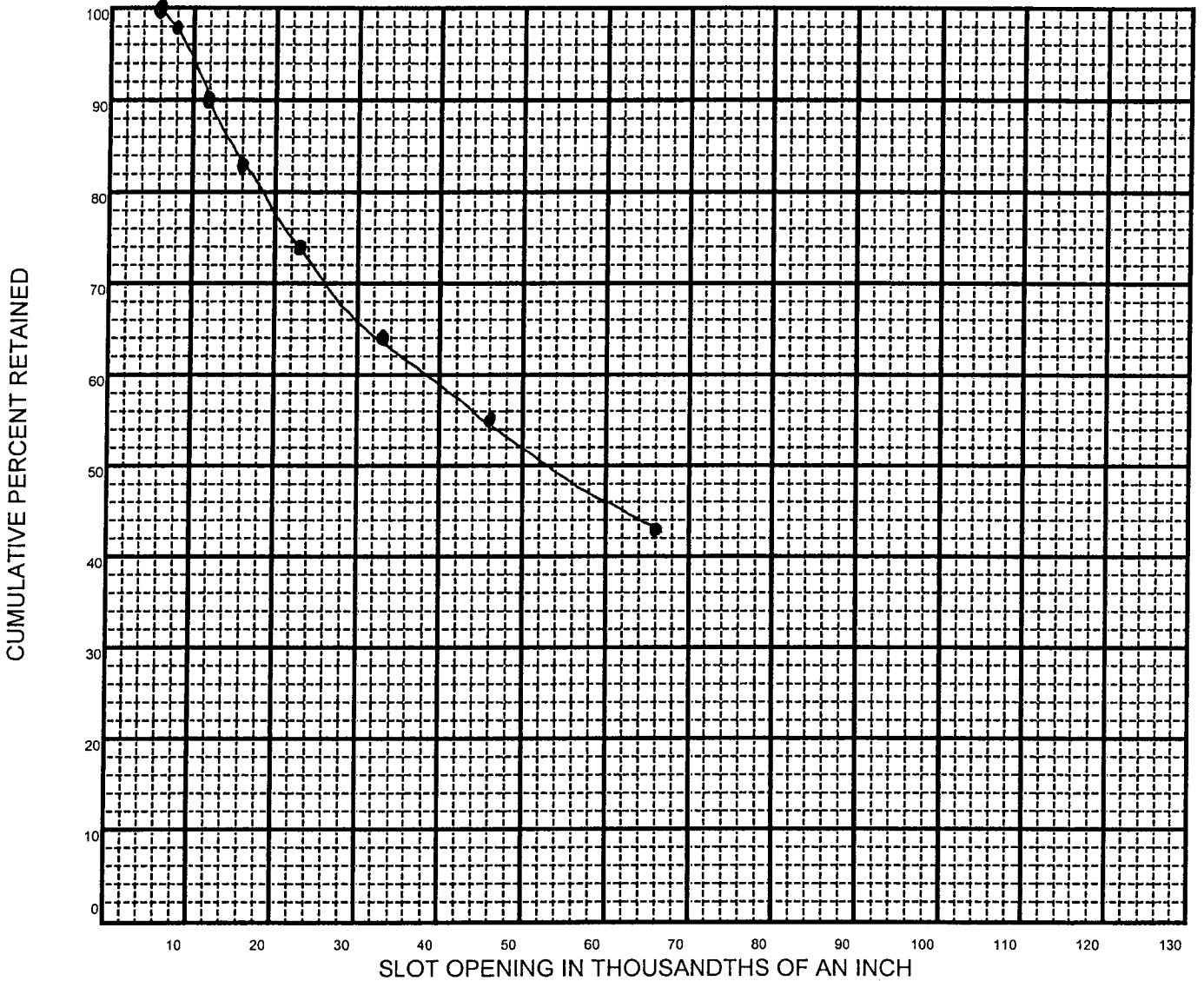

SIEVE OPENING	CUMULATIVE PERCENT RETAINED	
0.066	<b>43</b>	
0.046	<b>55</b>	
0.039		
0.033	<b>64</b>	
0.023	<b>74</b>	
0.016	<b>83</b>	
0.012	<b>90</b>	
0.008	<b>98</b>	
0.006	<b>100</b>	
PAN		
SCREEN SLOT		

NOTES: \_\_\_\_\_  
 \_\_\_\_\_  
 \_\_\_\_\_

SLOT OPENING RECOMMENDED: 0.030

RECOMMENDED SCREEN: DIA: \_\_\_\_\_ IN. LENGTH \_\_\_\_\_ FT.

BY: Randy Hudson

SO MANY CONSIDERATION ENTER INTO THE MAKING OF A GOOD WELL THAT WHILE WE BELIEVE SLOT SIZES FURNISHED OR RECOMMENDED FROM SAND SAMPLES ARE CORRECT WE ASSUME NO RESPONSIBILITY FOR THE SUCCESSFUL OPERATION OF JOHNSON WELL SCREENS

# SAND ANALYSIS

## A.C. SCHULTES, INC.

Site Dare County #15 State North Carolina Date: 11/12/04  
 From Well of \_\_\_\_\_ #15  
 Remarks 300 - 310 Feet

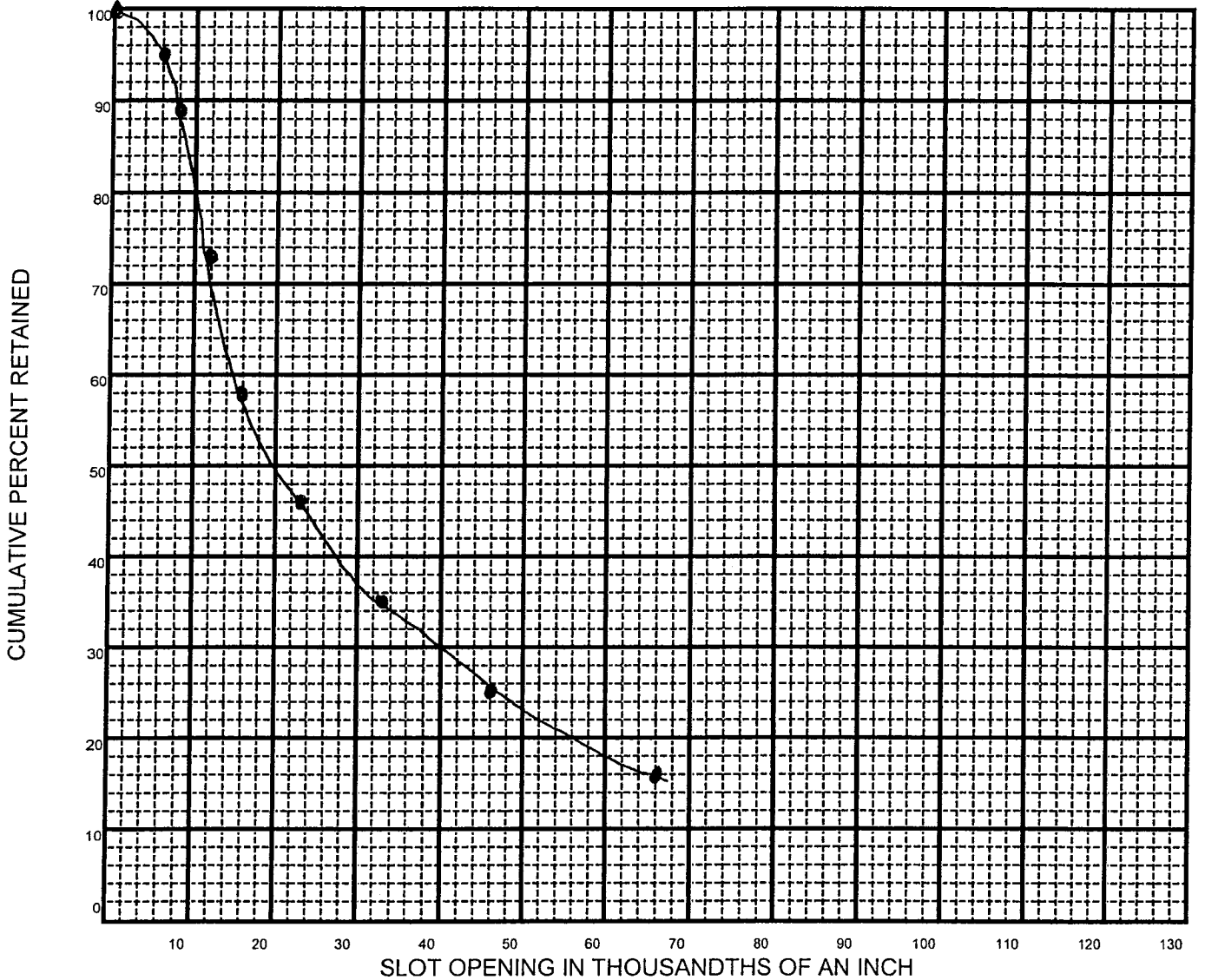

SIEVE OPENING	CUMULATIVE PERCENT RETAINED	
0.066	16	
0.046	25	
0.039		
0.033	35	
0.023	46	
0.016	58	
0.012	73	
0.008	89	
0.006	95	
PAN	100	
SCREEN SLOT		

NOTES: \_\_\_\_\_

SLOT OPENING RECOMMENDED: 0.030

RECOMMENDED SCREEN: DIA: \_\_\_\_\_ IN. LENGTH \_\_\_\_\_ FT.

BY: Randy Hudson

SO MANY CONSIDERATION ENTER INTO THE MAKING OF A GOOD WELL THAT WHILE WE BELIEVE SLOT SIZES FURNISHED OR RECOMMENDED FROM SAND SAMPLES ARE CORRECT WE ASSUME NO RESPONSIBILITY FOR THE SUCCESSFUL OPERATION OF JOHNSON WELL SCREENS



# SAND ANALYSIS

## A.C. SCHULTES, INC.

Site Dare County #15 State North Carolina Date: 11/12/04  
 From Well of \_\_\_\_\_ #15  
 Remarks \_\_\_\_\_ 310 - 320 Feet

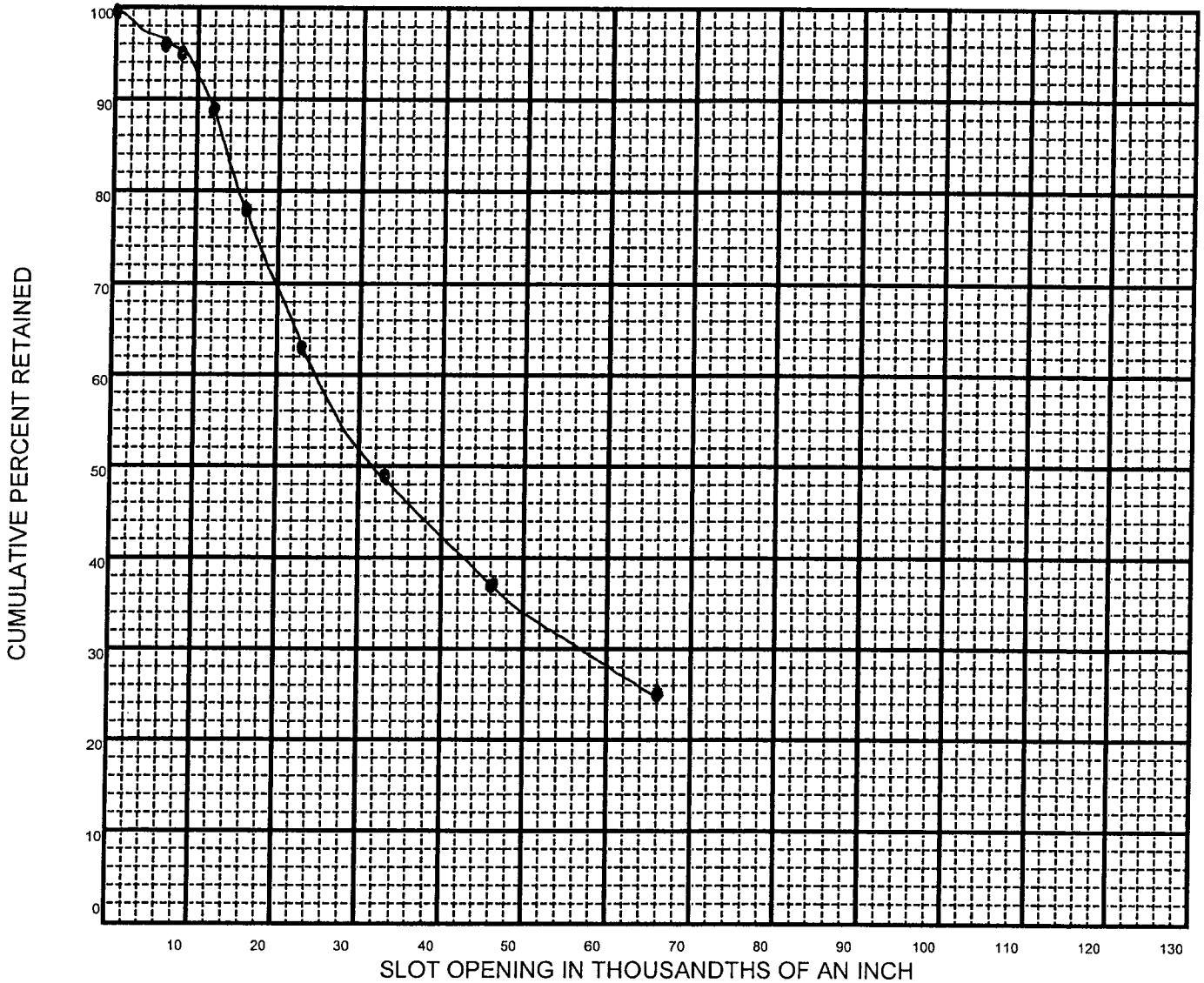

SIEVE OPENING	CUMULATIVE PERCENT RETAINED		
0.066	25		
0.046	37		
0.039			
0.033	49		
0.023	63		
0.016	78		
0.012	89		
0.008	95		
0.006	96		
PAN	100		
SCREEN SLOT			

NOTES: \_\_\_\_\_  
 \_\_\_\_\_  
 \_\_\_\_\_

SLOT OPENING RECOMMENDED: 0.030

RECOMMENDED SCREEN: DIA: \_\_\_\_\_ IN. LENGTH \_\_\_\_\_ FT.

BY: Randy Hudson

SO MANY CONSIDERATION ENTER INTO THE MAKING OF A GOOD WELL THAT WHILE WE BELIEVE SLOT SIZES FURNISHED OR RECOMMENDED FROM SAND SAMPLES ARE CORRECT WE ASSUME NO RESPONSIBILITY FOR THE SUCCESSFUL OPERATION OF JOHNSON WELL SCREENS

# SAND ANALYSIS

## A.C. SCHULTES, INC.

Site Dare County #15 State North Carolina Date: 11/12/04  
 From Well of \_\_\_\_\_ #15  
 Remarks 320 - 330 Feet

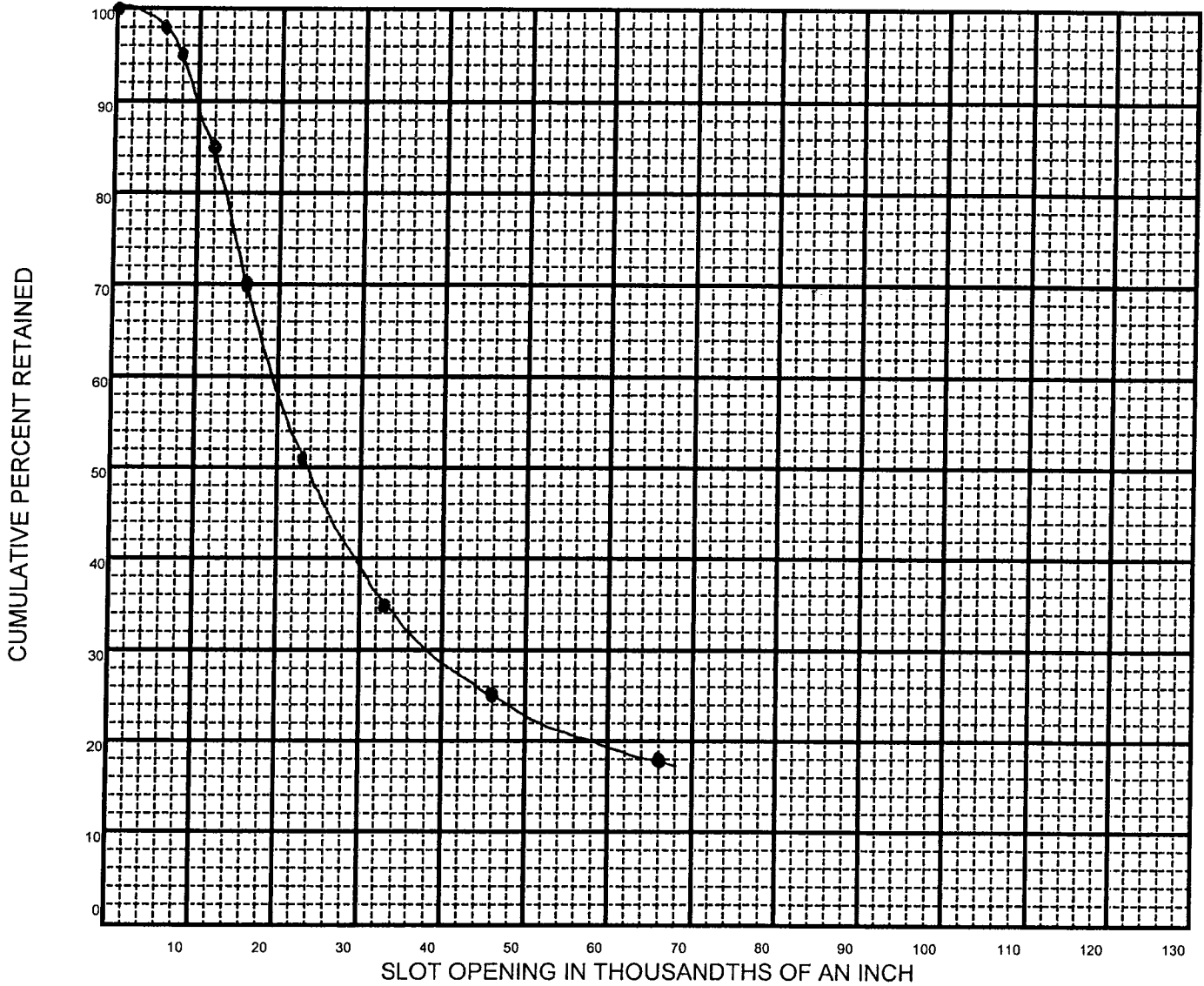

SIEVE OPENING	CUMULATIVE PERCENT RETAINED
0.066	18
0.046	25
0.039	
0.033	35
0.023	51
0.016	70
0.012	85
0.008	95
0.006	98
PAN	100
SCREEN SLOT	

NOTES: \_\_\_\_\_  
 \_\_\_\_\_  
 \_\_\_\_\_

SLOT OPENING RECOMMENDED: 0.030

RECOMMENDED SCREEN: DIA: \_\_\_\_\_ IN. LENGTH \_\_\_\_\_ FT.

BY: Randy Hudson

SO MANY CONSIDERATION ENTER INTO THE MAKING OF A GOOD WELL THAT WHILE WE BELIEVE SLOT SIZES FURNISHED OR RECOMMENDED FROM SAND SAMPLES ARE CORRECT WE ASSUME NO RESPONSIBILITY FOR THE SUCCESSFUL OPERATION OF JOHNSON WELL SCREENS

# SAND ANALYSIS

## A.C. SCHULTES, INC.

Site Dare County #15 State North Carolina Date: 11/12/04  
 From Well of \_\_\_\_\_ #15  
 Remarks 330 - 340 Feet

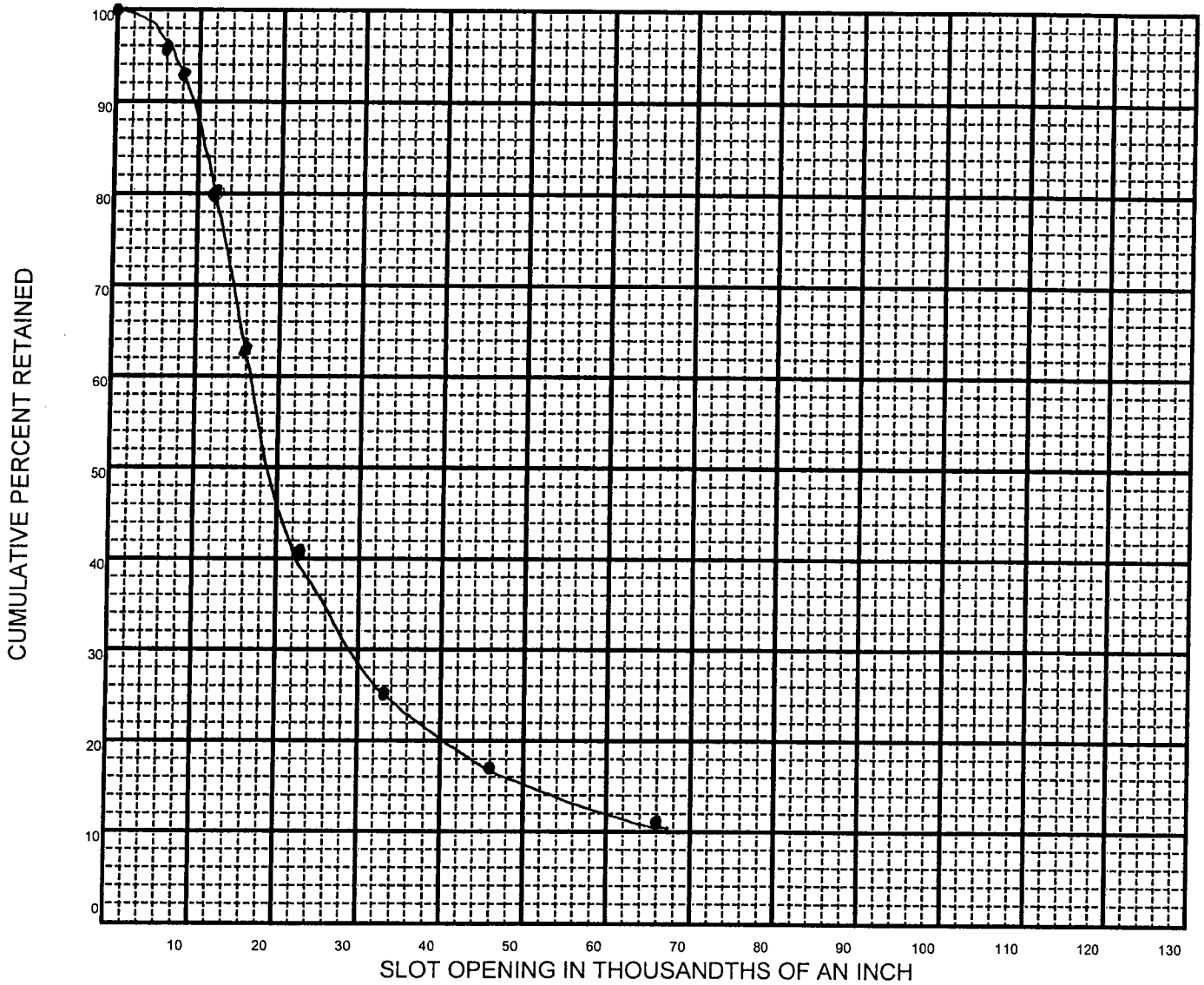

SIEVE OPENING	CUMULATIVE PERCENT RETAINED
0.066	11
0.046	17
0.039	
0.033	25
0.023	41
0.016	63
0.012	80
0.008	93
0.006	96
PAN	100
SCREEN SLOT	

NOTES: \_\_\_\_\_  
 \_\_\_\_\_  
 \_\_\_\_\_

SLOT OPENING RECOMMENDED: 0.030

RECOMMENDED SCREEN: DIA: \_\_\_\_\_ IN. LENGTH \_\_\_\_\_ FT.

BY: Randy Hudson

SO MANY CONSIDERATION ENTER INTO THE MAKING OF A GOOD WELL THAT WHILE WE BELIEVE SLOT SIZES FURNISHED OR RECOMMENDED FROM SAND SAMPLES ARE CORRECT WE ASSUME NO RESPONSIBILITY FOR THE SUCCESSFUL OPERATION OF JOHNSON WELL SCREENS

# SAND ANALYSIS

## A.C. SCHULTES, INC.

Site Dare County #15 State North Carolina Date: 11/12/04  
 From Well of \_\_\_\_\_ #15  
 Remarks 340 - 350 Feet

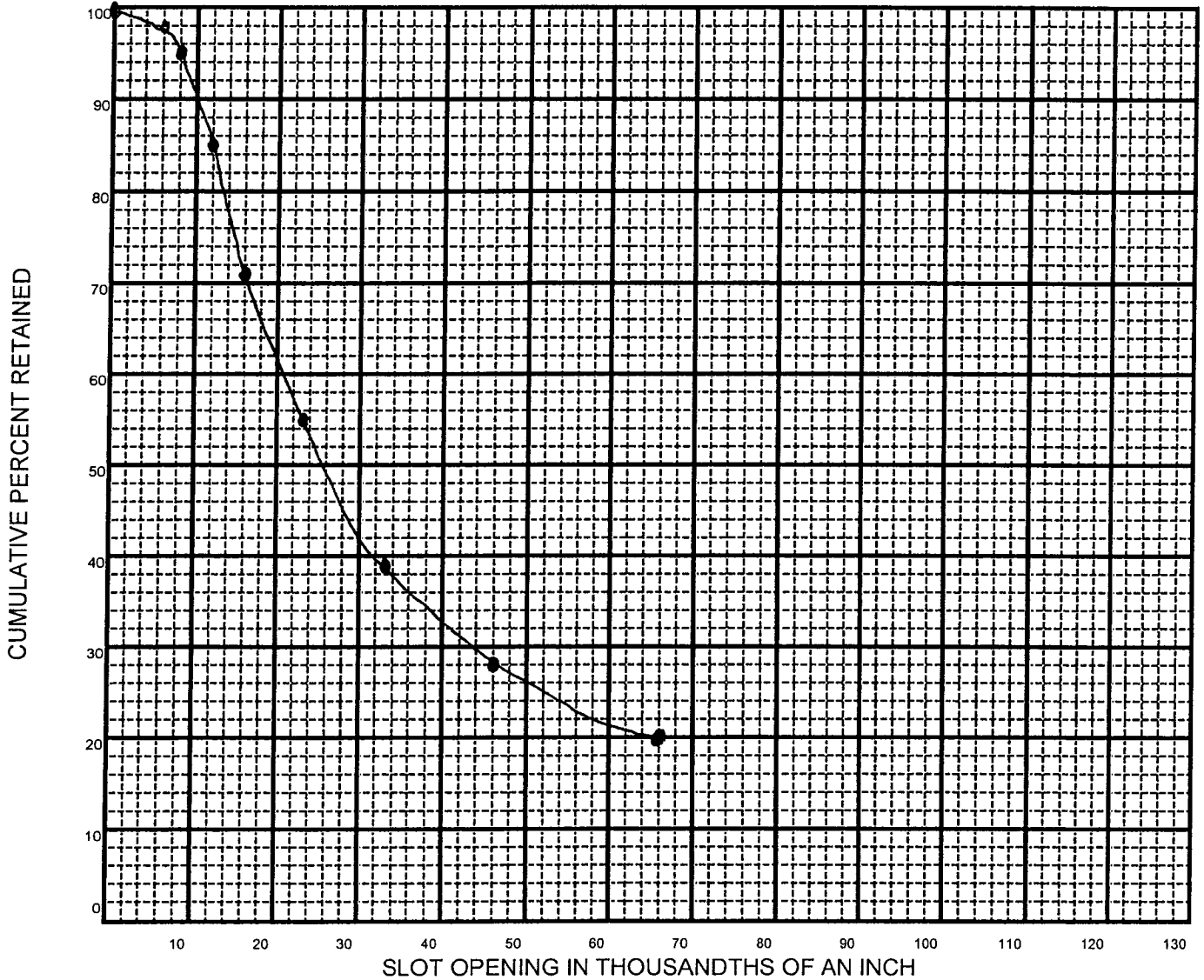

SIEVE OPENING	CUMULATIVE PERCENT RETAINED	
0.066	20	
0.046	28	
0.039		
0.033	39	
0.023	55	
0.016	71	
0.012	85	
0.008	95	
0.006	98	
PAN	100	
SCREEN SLOT		

NOTES: \_\_\_\_\_

SLOT OPENING RECOMMENDED: 0.030

RECOMMENDED SCREEN: DIA: \_\_\_\_\_ IN. LENGTH \_\_\_\_\_ FT.

BY: Randy Hudson

SO MANY CONSIDERATION ENTER INTO THE MAKING OF A GOOD WELL THAT WHILE WE BELIEVE SLOT SIZES FURNISHED OR RECOMMENDED FROM SAND SAMPLES ARE CORRECT WE ASSUME NO RESPONSIBILITY FOR THE SUCCESSFUL OPERATION OF JOHNSON WELL SCREENS

# SAND ANALYSIS

## A.C. SCHULTES, INC.

Site Dare County #15 State North Carolina Date: 11/12/04  
 From Well of \_\_\_\_\_ #15  
 Remarks 350 - 360 Feet

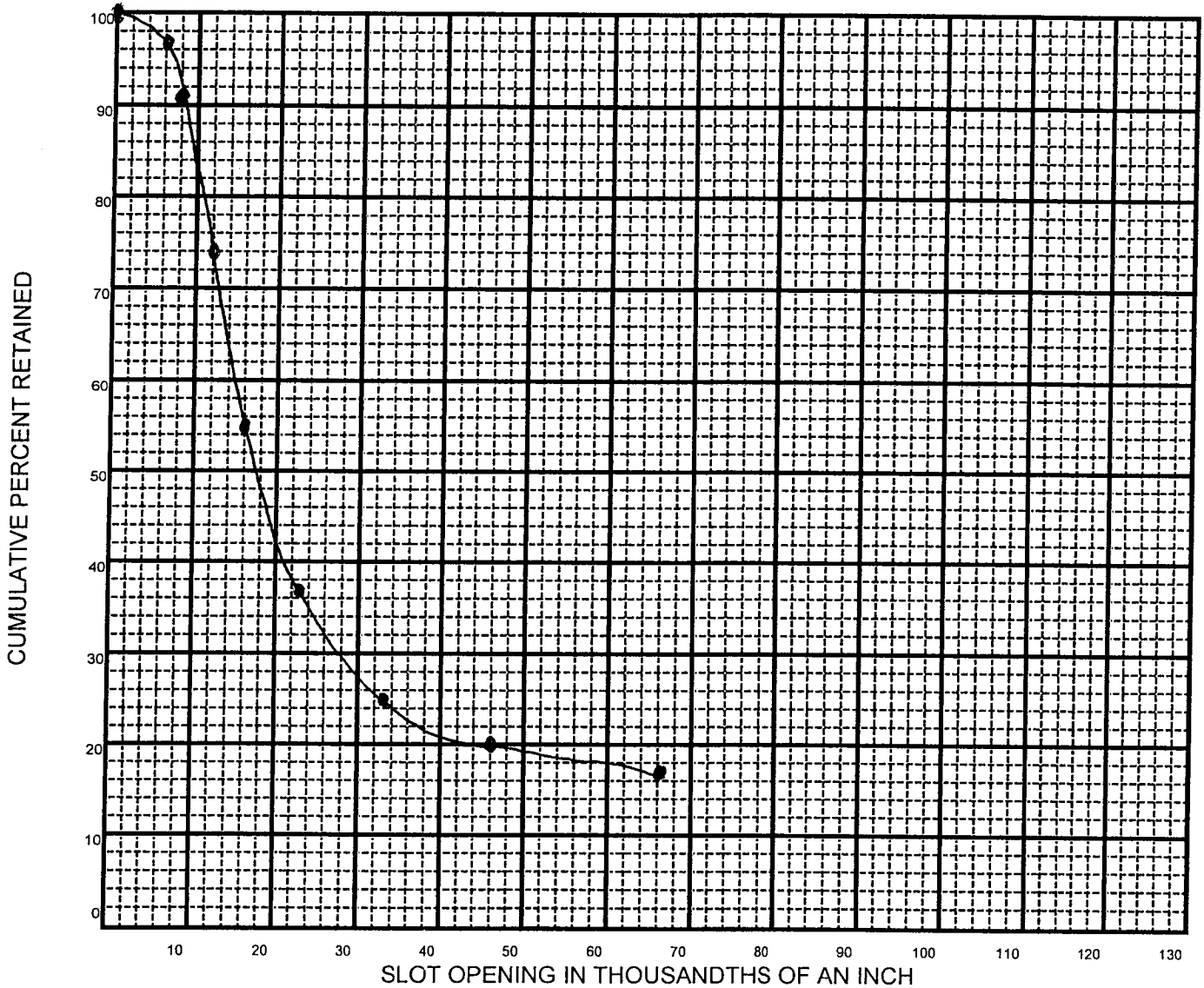

SIEVE OPENING	CUMULATIVE PERCENT RETAINED		
0.066	17		
0.046	20		
0.039			
0.033	25		
0.023	37		
0.016	55		
0.012	74		
0.008	91		
0.006	97		
PAN	100		
SCREEN SLOT			

NOTES: \_\_\_\_\_  
 \_\_\_\_\_  
 \_\_\_\_\_

SLOT OPENING RECOMMENDED: 0.030

RECOMMENDED SCREEN: DIA: \_\_\_\_\_ IN. LENGTH \_\_\_\_\_ FT.

BY: Randy Hudson

SO MANY CONSIDERATION ENTER INTO THE MAKING OF A GOOD WELL THAT WHILE WE BELIEVE SLOT SIZES FURNISHED OR RECOMMENDED FROM SAND SAMPLES ARE CORRECT WE ASSUME NO RESPONSIBILITY FOR THE SUCCESSFUL OPERATION OF JOHNSON WELL SCREENS

# SAND ANALYSIS

## A.C. SCHULTES, INC.

Site Dare County #15 State North Carolina Date: 11/12/04  
 From Well of \_\_\_\_\_ #15  
 Remarks 360 - 370 Feet

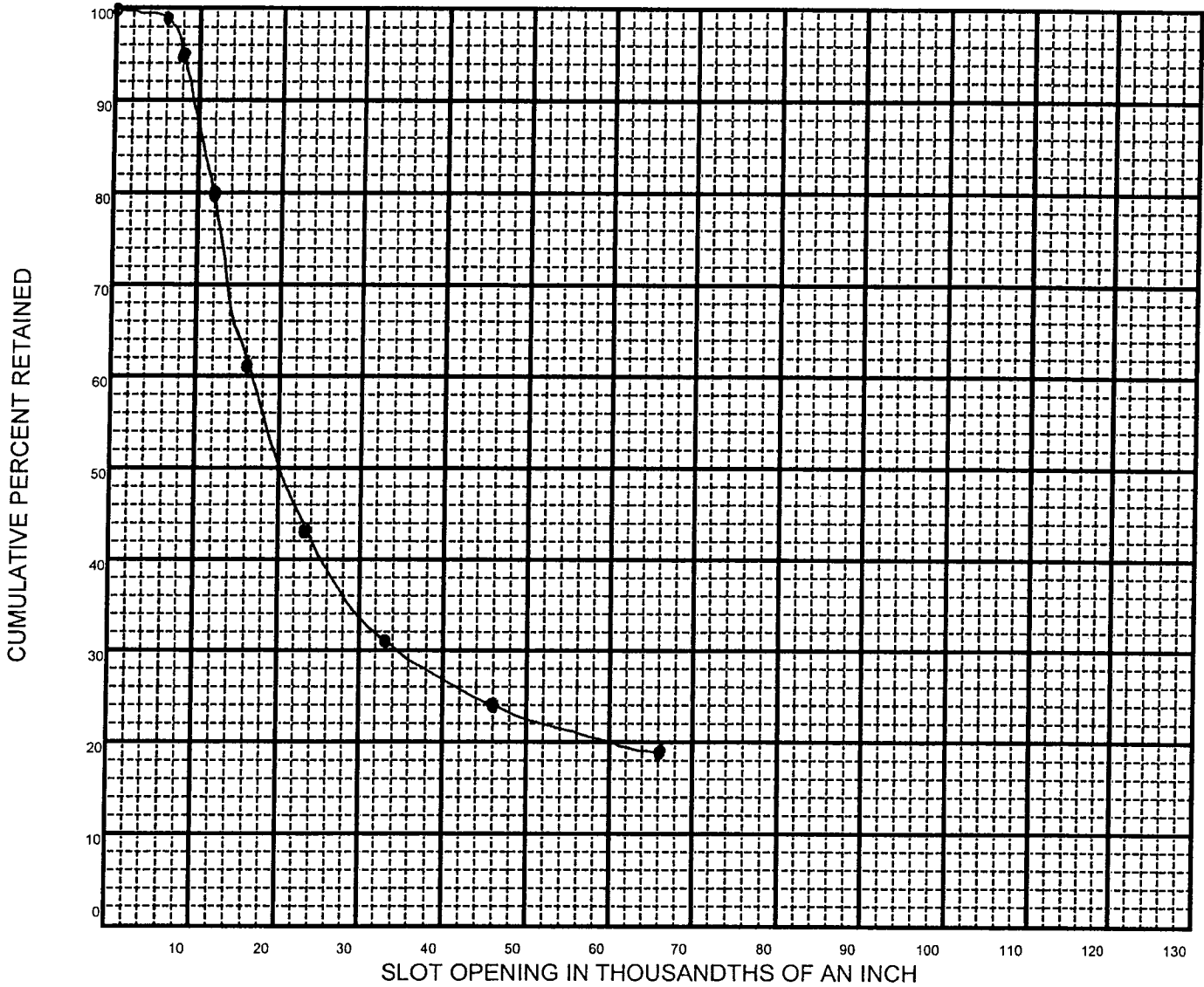

SIEVE OPENING	CUMULATIVE PERCENT RETAINED
0.066	19
0.046	24
0.039	
0.033	31
0.023	43
0.016	61
0.012	80
0.008	95
0.006	99
PAN	100
SCREEN SLOT	

NOTES: \_\_\_\_\_

SLOT OPENING RECOMMENDED: 0.030

RECOMMENDED SCREEN: DIA: \_\_\_\_\_ IN. LENGTH \_\_\_\_\_ FT.

BY: Randy Hudson

SO MANY CONSIDERATION ENTER INTO THE MAKING OF A GOOD WELL THAT WHILE WE BELIEVE SLOT SIZES FURNISHED OR RECOMMENDED FROM SAND SAMPLES ARE CORRECT WE ASSUME NO RESPONSIBILITY FOR THE SUCCESSFUL OPERATION OF JOHNSON WELL SCREENS

# SAND ANALYSIS

## A.C. SCHULTES, INC.

Site Dare County #15 State North Carolina Date: 11/12/04  
 From Well of \_\_\_\_\_ #15  
 Remarks 370 - 380 Feet

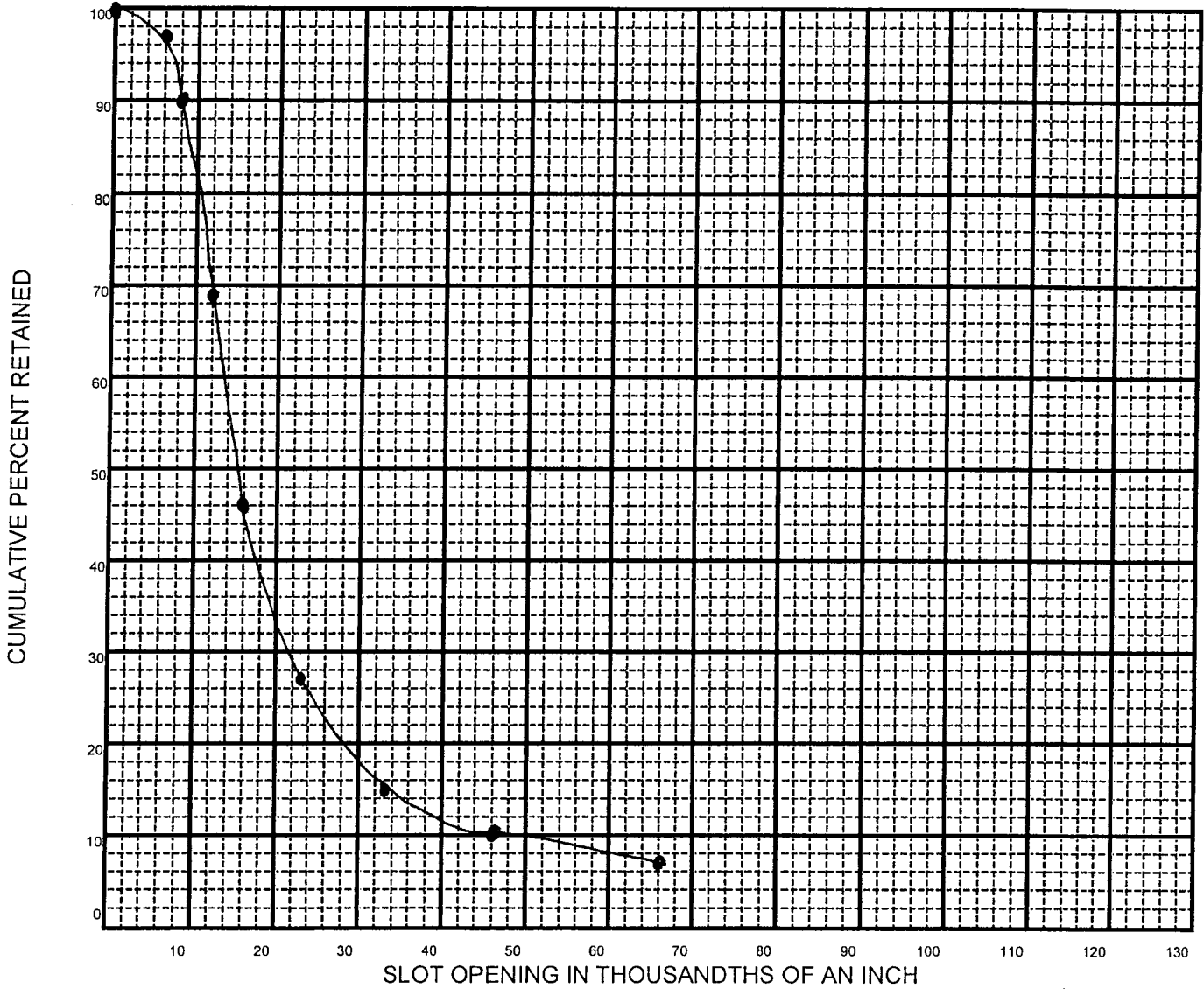

SIEVE OPENING	CUMULATIVE PERCENT RETAINED
0.066	7
0.046	10
0.039	
0.033	15
0.023	27
0.016	46
0.012	69
0.008	90
0.006	97
PAN	100
SCREEN	
SLOT	

NOTES: \_\_\_\_\_

SLOT OPENING RECOMMENDED: 0.030

RECOMMENDED SCREEN: DIA: \_\_\_\_\_ IN. LENGTH \_\_\_\_\_ FT.

BY: Randy Hudson

SO MANY CONSIDERATION ENTER INTO THE MAKING OF A GOOD WELL THAT WHILE WE BELIEVE SLOT SIZES FURNISHED OR RECOMMENDED FROM SAND SAMPLES ARE CORRECT WE ASSUME NO RESPONSIBILITY FOR THE SUCCESSFUL OPERATION OF JOHNSON WELL SCREENS

# SAND ANALYSIS

## A.C. SCHULTES, INC.

Site Dare County #15 State North Carolina Date: 11/12/04  
 From Well of \_\_\_\_\_ #15  
 Remarks 380 - 390 Feet

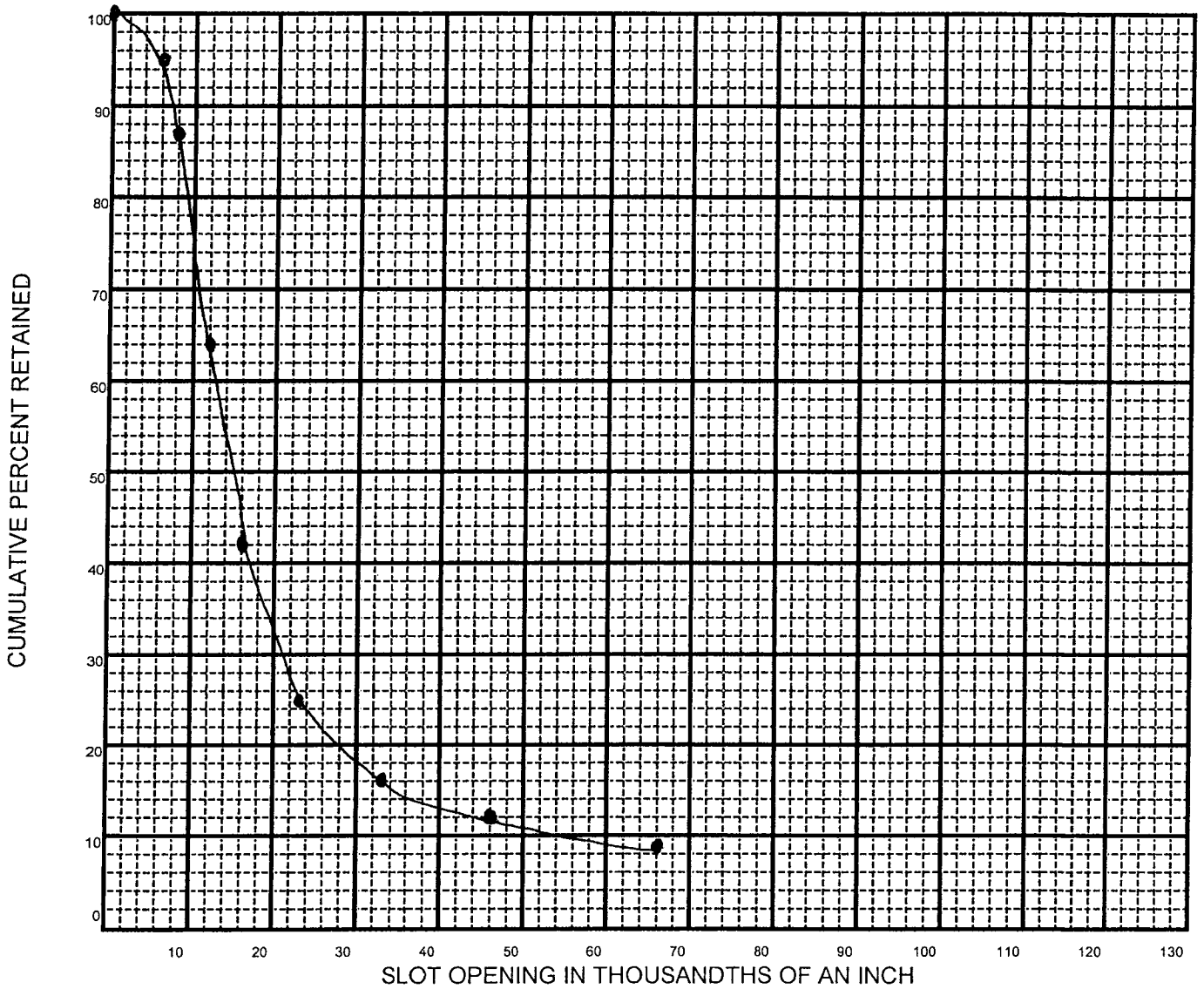

SIEVE OPENING	CUMULATIVE PERCENT RETAINED
0.066	9
0.046	12
0.039	
0.033	16
0.023	25
0.016	42
0.012	64
0.008	87
0.006	95
PAN	100
SCREEN SLOT	

NOTES: \_\_\_\_\_  
 \_\_\_\_\_  
 \_\_\_\_\_

SLOT OPENING RECOMMENDED: 0.030

RECOMMENDED SCREEN: DIA: \_\_\_\_\_ IN. LENGTH \_\_\_\_\_ FT.

BY: Randy Hudson

SO MANY CONSIDERATION ENTER INTO THE MAKING OF A GOOD WELL THAT WHILE WE BELIEVE SLOT SIZES FURNISHED OR RECOMMENDED FROM SAND SAMPLES ARE CORRECT WE ASSUME NO RESPONSIBILITY FOR THE SUCCESSFUL OPERATION OF JOHNSON WELL SCREENS



# SAND ANALYSIS

## A.C. SCHULTES, INC.

Site Dare County #15 State North Carolina Date: 11/12/04  
 From Well of \_\_\_\_\_ #15  
 Remarks 390 - 400 Feet

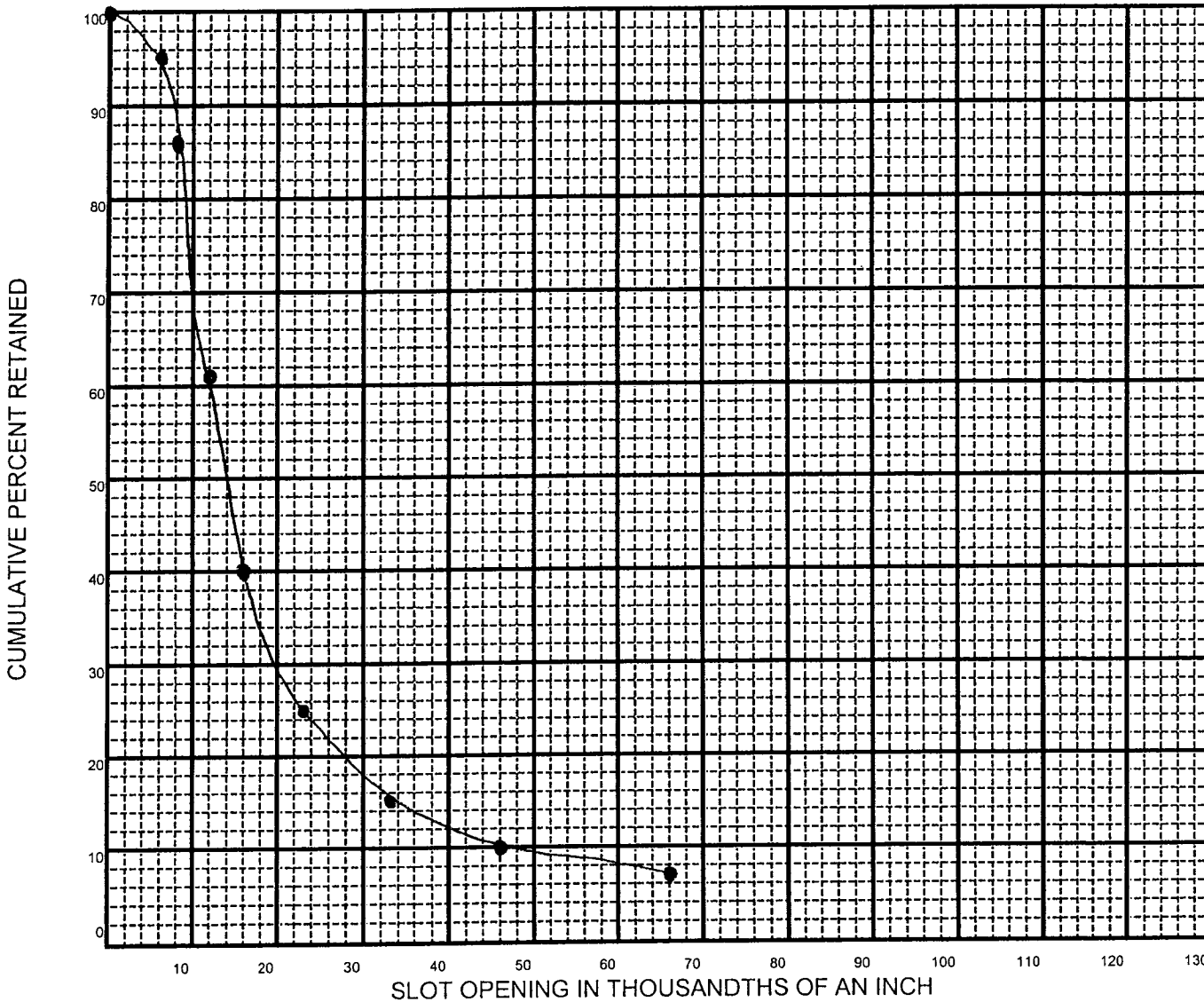

SIEVE OPENING	CUMULATIVE PERCENT RETAINED	
0.066	<b>7</b>	
0.046	<b>10</b>	
0.039		
0.033	<b>15</b>	
0.023	<b>25</b>	
0.016	<b>40</b>	
0.012	<b>61</b>	
0.008	<b>86</b>	
0.006	<b>95</b>	
PAN	<b>100</b>	
SCREEN SLOT		

NOTES: \_\_\_\_\_

SLOT OPENING RECOMMENDED: 0.030

RECOMMENDED SCREEN: DIA: \_\_\_\_\_ IN. LENGTH \_\_\_\_\_ FT.

BY: Randy Hudson

SO MANY CONSIDERATION ENTER INTO THE MAKING OF A GOOD WELL THAT WHILE WE BELIEVE SLOT SIZES FURNISHED OR RECOMMENDED FROM SAND SAMPLES ARE CORRECT WE ASSUME NO RESPONSIBILITY FOR THE SUCCESSFUL OPERATION OF JOHNSON WELL SCREENS

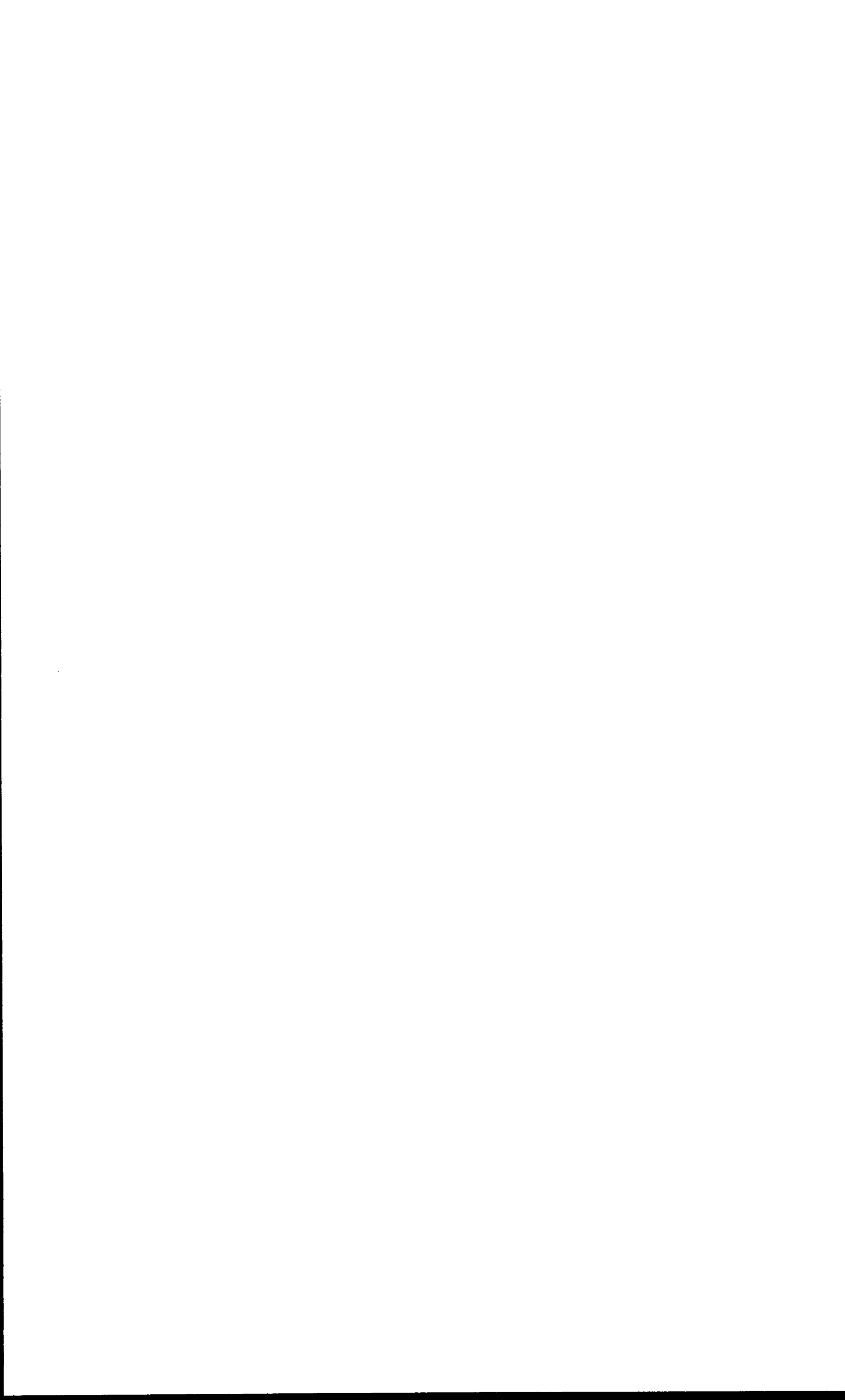



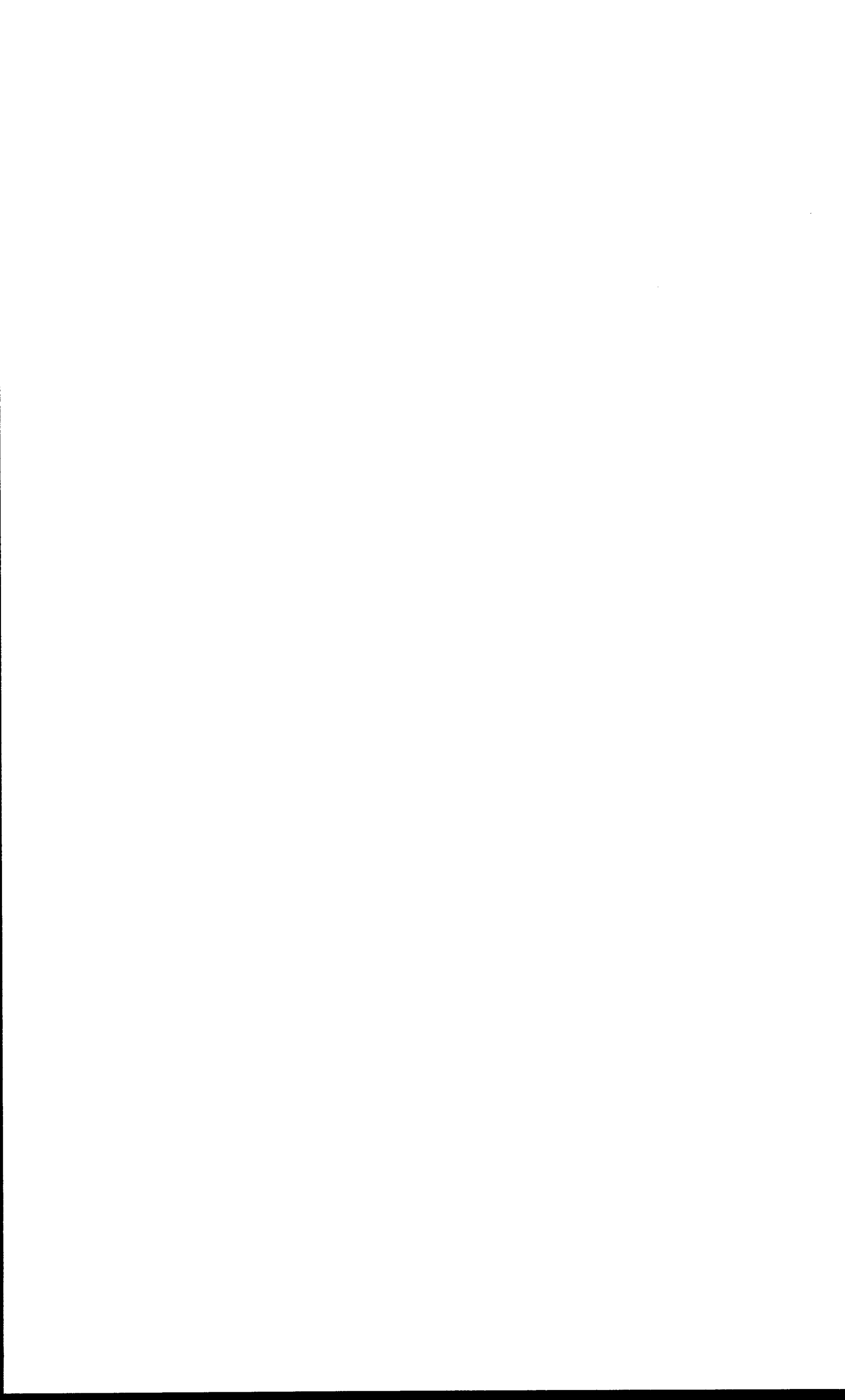

# Well Yield and Drawdown Report

## Production Well #15

Submitted By: *Mathew F. Colone*  
Mathew F. Colone, P.G.  
North Carolina Professional Geologist No. 1851

**37 Hour Constant Rate Pump Test at Production Well #15  
Nags Head, North Carolina**

<b>Pumping Well #15</b>				
Begin Test Date: 21 December 2004 (0722 hrs)				
End Test Date: 22 December 2004 (2037 hrs)				
Pumping Rate: 600 GPM				
Recorded By: A.C. Schultes				
Static Water Level: 17' Below Top of Casing (btoc)				
Pumping Rate (GPM)	Time (Minutes)	Water Level (btoc)	Drawdown (feet)	Specific Capacity (gpm/ft)
600	0	17	0	
	0.5	60.14	30.44	
	1	59.12	29.42	
	5	51.50	21.80	
	10	52.25	22.55	
	15	53.25	23.55	
	20	53.63	23.93	25.1
	25	55.77	26.07	
	30	56.15	26.45	
	35	56.00	26.30	
	40	56.83	27.13	
	45	56.80	27.10	
	50	57.11	27.41	
	55	57.50	27.80	
	60	57.81	28.11	
	70	57.86	28.16	21.3
	80	58.18	28.48	
	90	58.55	28.85	
	100	58.38	28.68	
	120	58.71	29.01	
	140	58.96	29.26	
	160	59.26	29.56	
	180	59.56	29.86	
	200	59.94	30.24	19.8
	220	59.52	29.82	
	240	60.08	30.38	
	260	59.94	30.24	
	280	60.73	31.03	
	300	60.04	30.34	
	340	60.57	30.87	
	380	60.89	31.19	
	480	63.29	33.59	17.9
	580	63.55	33.85	
	680	64.20	34.50	
	780	64.46	34.76	
	880	65.02	35.32	
	980	64.94	35.24	
	1080	64.78	35.08	
	1180	64.96	35.26	
	1280	64.95	35.25	17.0
	1380	65.06	35.36	
	1480	65.71	36.01	
	1580	65.67	35.97	
	1680	66.16	36.46	
	1780	65.65	35.95	
	1880	65.90	36.20	
	1980	65.50	35.80	
	2080	65.15	35.45	16.9
	2180	65.86	36.16	
	2235	66.48	36.78	16.3

\*Measuring point is Top of Casing approximately 3 feet above land surface.

**Step-Drawdown Test Results for Production Well #15  
Nags Head, North Carolina**

<b>Production Well #15</b> Test Date: 20 December 2004 Recorded By: A.C. Schultes Static Water Level: 17' Below Top of Casing (btoc)					
Pumping Rate (GPM)	Time (minutes)	Water Level (btoc)	Drawdown (feet)	Specific Capacity (gpm/ft)	Comments
400	0	17	0.000	22.9	
	5	30.40	13.397		
	10	31.13	14.132		
	20	33.62	16.621		
	30	33.67	16.667		
	40	33.48	16.480		
	50	34.66	17.661		
	60	34.46	17.460		
500	0	34.46	17.460	21.9	
	5	38.25	21.248		
	10	38.91	21.911		
	20	39.53	22.530		
	30	38.72	21.724		
	40	39.24	22.242		
	50	39.06	22.055		
	60	39.82	22.819		
600	0	39.82	22.819	21.8	
	5	43.41	26.405		
	10	43.82	26.823		
	20	43.51	26.506		
	30	43.58	26.578		
	40	43.87	26.866		
	50	44.15	27.154		
	60	44.53	27.529		
800	0	44.53	27.529	21.9	
	5	52.45	35.450		
	10	52.58	35.580		
	20	52.85	35.853		
	30	53.06	36.055		
	40	53.06	36.055		
	50	53.59	36.588		
	60	53.59	36.588		
970	0	53.59	36.588	21.6	
	5	60.33	43.327		
	10	60.80	43.802		
	20	61.16	44.162		
	30	61.48	44.478		
	40	61.39	44.392		
	50	61.59	44.594		
	60	61.90	44.896		

\*Measuring Point is Top of Casing (approximately 3 feet above land surface).

# PUMPING WELL #15 5 HOUR STEP TEST RESULTS

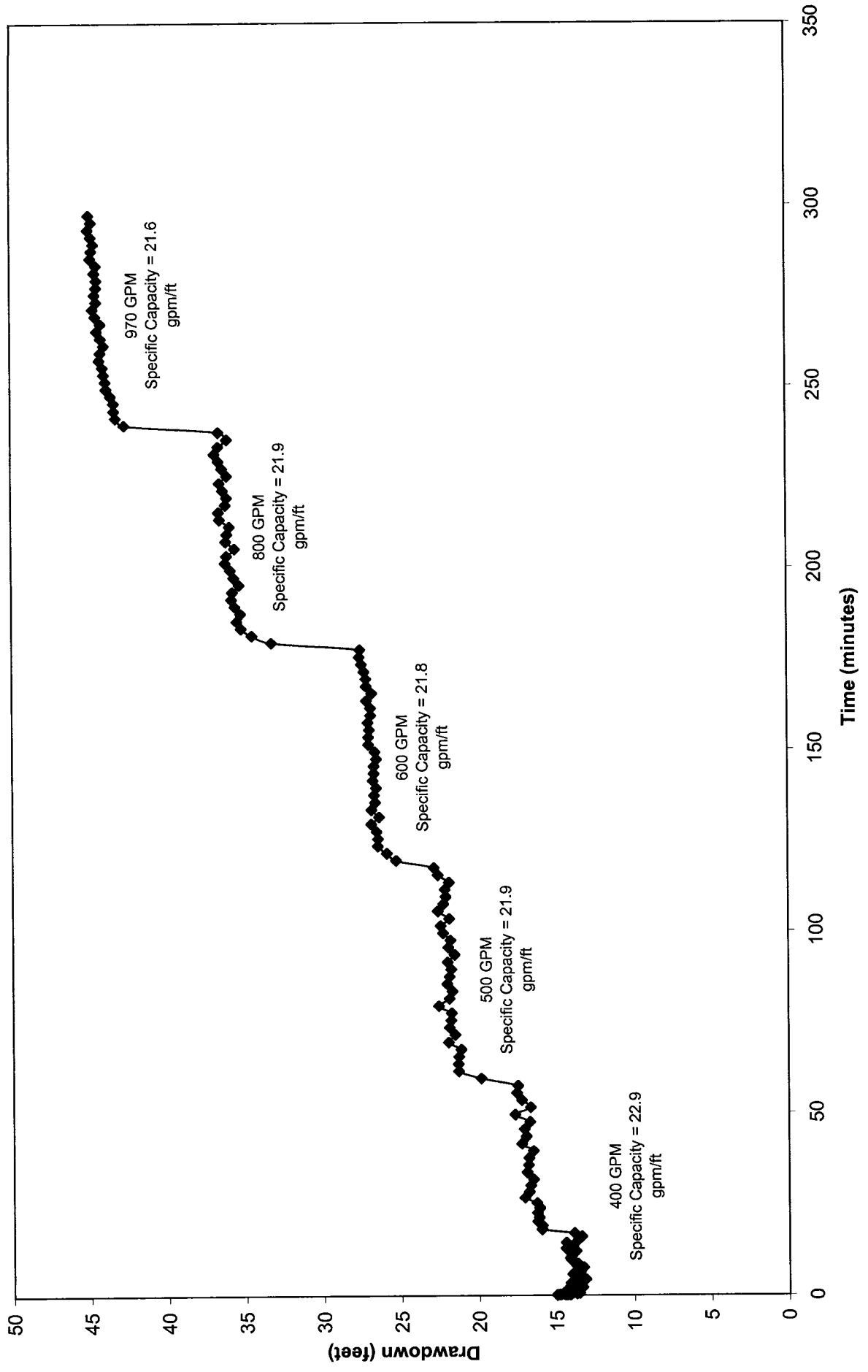

Dare County Water Department  
Graph Showing Drawdown in Pumping Well #15  
While Pumping at Rates of 400, 500, 600, 800, and 970 GPM



**PUMPING WELL #15  
37 HOUR CONSTANT RATE TEST RESULTS**

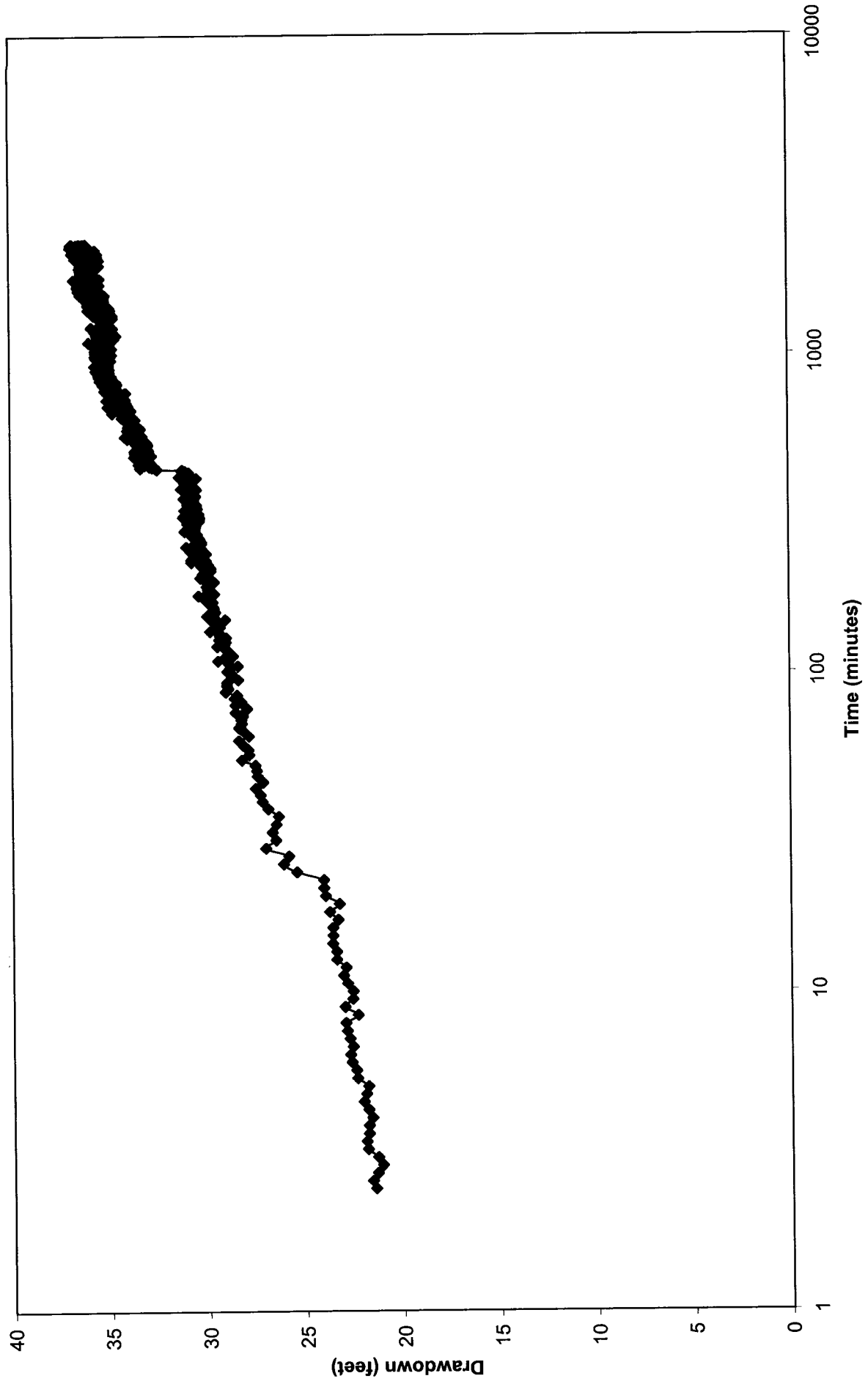

Dare County Water Department  
Semi-Log Graph Showing Drawdown vs. Time in Pumping Well #15  
While Pumping at 600 GPM

**Recovery Test Results for Production Well #15  
Nags Head, North Carolina**

<b>Production Well #15</b>		
Begin Test Date: 22 December 2004 (2038 hrs)		
End Test Date: 24 December 2004 (0736 hrs)		
Recorded By: A.C. Schultes		
Static Water Level: 17' Below Top of Casing (btoc)		
Time (Minutes)	Water Level (btoc)	Recovery (feet)
0	52.93	35.93
1	31.54	14.54
5	28.50	11.50
10	27.39	10.39
15	26.74	9.74
20	26.28	9.28
25	25.90	8.90
30	25.64	8.64
35	25.37	8.37
40	25.20	8.20
45	24.97	7.97
50	24.85	7.85
60	24.55	7.55
100	23.74	6.74
150	23.08	6.08
200	22.56	5.56
250	22.08	5.08
300	21.67	4.67
400	20.87	3.87
600	19.96	2.96
800	19.99	2.99
1000	19.86	2.86
1200	19.17	2.17
1400	19.66	2.66
1600	19.89	2.89
1800	19.29	2.29
2000	18.57	1.57
2097	17.86	0.86

\*Measuring point is Top of Casing approximately 3 feet above land surface.

PUMPING WELL #15  
RECOVERY TEST RESULTS

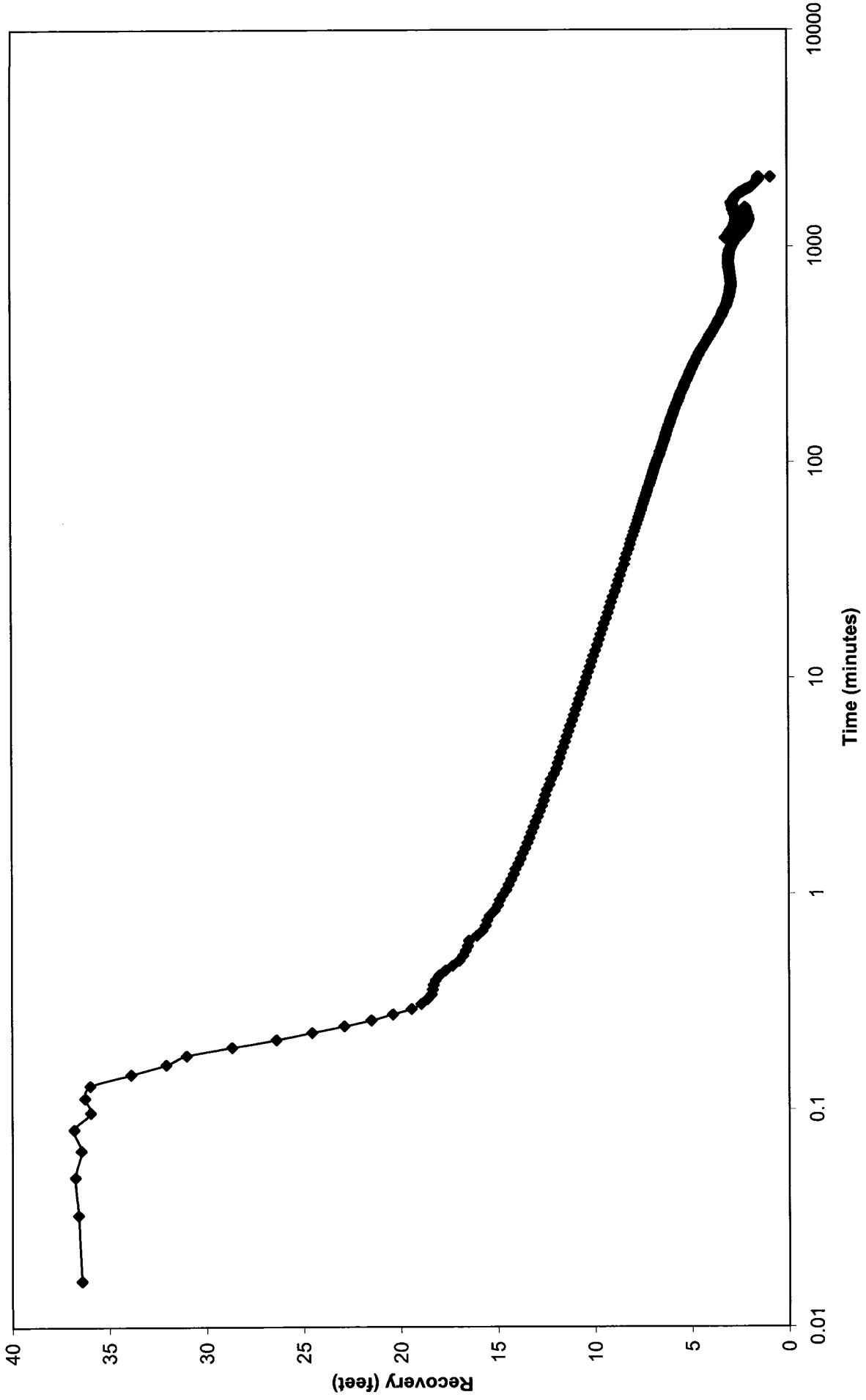

In-Situ Inc. Hermit 3000

Report gener 1/11/2005 9:34:49  
Report from I C:\Win-Situ\Data\SN45813 2004-12-20 082225 DARE STEP .bin  
DataMgr Ver 3.68

Serial numbe 45813  
Firmware Ve 7.1  
Unit name: HERMIT 3000

Test name: DARE STEP

Test defined ##### 14:20:41  
Test started ##### 8:22:25  
Test stopped ##### 13:22:13  
Test extracte 1/7/2005 13:22:20

Data gathered using Logarithmic testing

Maximum t Minutes.  
Number of 237

TOTAL DAT, 237

Channel number [7]

Measureme Pressure

Channel na #7

Linearity: 0.2503

Scale: 99.8402

Offset: -0.1892

Warmup: 50

Specific gra 1

Mode: TOC

User-define 17 Feet H2O

Referenced channel definition.

Pressure hε 58.366 Feet H2O

Channel number [8]

Measureme Pressure

Channel na #8

Linearity: 0.2257

Scale: 99.3761

Offset: -0.1631

Warmup: 50

Specific gra 1

Mode: TOC

User-define 14 Feet H2O

Referenced channel definition.

Pressure hε 30.127 Feet H2O

Channel number [0]

Measureme Barometric Pressure

Channel na Barometric

Linearity: 0  
 Scale: 0  
 Offset: 0  
 Warmup: 50

Date	Time	ET (min)	#15 Feet H2O	Actual DD Feet	TW #15 Feet H2O	Actual DD Feet	Barometer Inches Hg
12/20/2004	8:22:25	0	31.333	14.333	17.089	3.089	29.962
12/20/2004	8:22:25	0.0162	31.996	14.996	17.074	3.074	29.964
12/20/2004	8:22:26	0.0323	31.809	14.809	17.074	3.074	29.962
12/20/2004	8:22:27	0.0485	31.29	14.29	17.074	3.074	29.962
12/20/2004	8:22:28	0.0647	31.276	14.276	17.06	3.06	29.962
12/20/2004	8:22:29	0.0808	31.809	14.809	17.046	3.046	29.966
12/20/2004	8:22:30	0.097	31.348	14.348	17.046	3.046	29.962
12/20/2004	8:22:31	0.1132	31.29	14.29	17.046	3.046	29.962
12/20/2004	8:22:32	0.1293	31.189	14.189	17.031	3.031	29.962
12/20/2004	8:22:33	0.1455	31.78	14.78	17.031	3.031	29.962
12/20/2004	8:22:34	0.1617	31.477	14.477	17.031	3.031	29.964
12/20/2004	8:22:35	0.1778	31.117	14.117	17.017	3.017	29.966
12/20/2004	8:22:36	0.194	31.247	14.247	17.017	3.017	29.966
12/20/2004	8:22:37	0.2102	31.506	14.506	17.017	3.017	29.966
12/20/2004	8:22:38	0.2263	31.405	14.405	17.017	3.017	29.97
12/20/2004	8:22:39	0.2425	31.506	14.506	17.017	3.017	29.968
12/20/2004	8:22:40	0.2587	31.348	14.348	17.003	3.003	29.966
12/20/2004	8:22:41	0.2748	31.276	14.276	16.988	2.988	29.968
12/20/2004	8:22:42	0.291	31.218	14.218	16.988	2.988	29.968
12/20/2004	8:22:43	0.3072	31.276	14.276	16.988	2.988	29.968
12/20/2004	8:22:44	0.3233	31.261	14.261	16.988	2.988	29.968
12/20/2004	8:22:45	0.34	31.593	14.593	16.974	2.974	29.97
12/20/2004	8:22:46	0.3577	31.521	14.521	16.974	2.974	29.968
12/20/2004	8:22:47	0.3763	31.189	14.189	16.974	2.974	29.964
12/20/2004	8:22:48	0.3962	31.463	14.463	16.974	2.974	29.968
12/20/2004	8:22:50	0.4172	30.728	13.728	16.974	2.974	29.966
12/20/2004	8:22:51	0.4393	31.074	14.074	16.974	2.974	29.968
12/20/2004	8:22:52	0.4628	31.261	14.261	16.945	2.945	29.968
12/20/2004	8:22:54	0.4877	31.42	14.42	16.96	2.96	29.966
12/20/2004	8:22:55	0.514	31.42	14.42	16.96	2.96	29.964
12/20/2004	8:22:57	0.542	31.549	14.549	16.945	2.945	29.968
12/20/2004	8:22:59	0.5717	30.555	13.555	16.931	2.931	29.968
12/20/2004	8:23:01	0.603	31.506	14.506	16.931	2.931	29.966
12/20/2004	8:23:03	0.6362	31.232	14.232	16.931	2.931	29.964
12/20/2004	8:23:05	0.6713	31.204	14.204	16.917	2.917	29.964
12/20/2004	8:23:07	0.7087	30.915	13.915	16.917	2.917	29.968
12/20/2004	8:23:09	0.7482	30.987	13.987	16.888	2.888	29.968
12/20/2004	8:23:12	0.79	31.434	14.434	16.874	2.874	29.968
12/20/2004	8:23:15	0.8343	30.598	13.598	16.874	2.874	29.968
12/20/2004	8:23:17	0.8813	30.959	13.959	16.874	2.874	29.968
12/20/2004	8:23:20	0.9312	30.987	13.987	16.859	2.859	29.968
12/20/2004	8:23:24	0.9838	31.146	14.146	16.859	2.859	29.966
12/20/2004	8:23:27	1.0397	30.872	13.872	16.845	2.845	29.97
12/20/2004	8:23:30	1.0988	31.117	14.117	16.831	2.831	29.972

12/20/2004	8:23:34	1.1615	31.333	14.333	16.845	2.845	29.966
12/20/2004	8:23:38	1.2278	30.815	13.815	16.831	2.831	29.97
12/20/2004	8:23:42	1.2982	30.743	13.743	16.816	2.816	29.966
12/20/2004	8:23:47	1.3727	30.829	13.829	16.802	2.802	29.97
12/20/2004	8:23:52	1.4517	30.973	13.973	16.802	2.802	29.97
12/20/2004	8:23:57	1.5353	30.959	13.959	16.802	2.802	29.962
12/20/2004	8:24:02	1.6238	30.642	13.642	16.788	2.788	29.964
12/20/2004	8:24:08	1.7177	31.045	14.045	16.788	2.788	29.96
12/20/2004	8:24:14	1.817	31.117	14.117	16.773	2.773	29.962
12/20/2004	8:24:20	1.9223	31.204	14.204	16.773	2.773	29.956
12/20/2004	8:24:27	2.0338	30.339	13.339	16.759	2.759	29.96
12/20/2004	8:24:34	2.152	30.541	13.541	16.745	2.745	29.966
12/20/2004	8:24:41	2.2772	30.656	13.656	16.745	2.745	29.962
12/20/2004	8:24:49	2.4097	30.483	13.483	16.745	2.745	29.966
12/20/2004	8:24:58	2.5502	30.944	13.944	16.73	2.73	29.962
12/20/2004	8:25:06	2.699	31.074	14.074	16.73	2.73	29.96
12/20/2004	8:25:16	2.8565	30.829	13.829	16.716	2.716	29.962
12/20/2004	8:25:26	3.0233	30.685	13.685	16.716	2.716	29.964
12/20/2004	8:25:37	3.2002	31.103	14.103	16.702	2.702	29.937
12/20/2004	8:25:48	3.3875	30.613	13.613	16.716	2.716	29.941
12/20/2004	8:26:00	3.5858	30.973	13.973	16.702	2.702	29.943
12/20/2004	8:26:12	3.796	30.771	13.771	16.687	2.687	29.948
12/20/2004	8:26:26	4.0187	30.354	13.354	16.702	2.702	29.948
12/20/2004	8:26:40	4.2545	30.152	13.152	16.702	2.702	29.952
12/20/2004	8:26:55	4.5043	30.57	13.57	16.687	2.687	29.952
12/20/2004	8:27:11	4.769	30.411	13.411	16.702	2.702	29.95
12/20/2004	8:27:27	5.0493	30.397	13.397	16.702	2.702	29.956
12/20/2004	8:27:45	5.3462	30.901	13.901	16.702	2.702	29.952
12/20/2004	8:28:04	5.6607	30.987	13.987	16.716	2.716	29.956
12/20/2004	8:28:24	5.9938	30.771	13.771	16.73	2.73	29.954
12/20/2004	8:28:45	6.3467	30.498	13.498	16.745	2.745	29.954
12/20/2004	8:29:08	6.7205	30.512	13.512	16.745	2.745	29.964
12/20/2004	8:29:31	7.1165	30.512	13.512	16.759	2.759	29.962
12/20/2004	8:29:57	7.5358	30.281	13.281	16.773	2.773	29.97
12/20/2004	8:30:23	7.9802	30.728	13.728	16.788	2.788	29.968
12/20/2004	8:30:52	8.4508	30.642	13.642	16.802	2.802	29.974
12/20/2004	8:31:21	8.9493	30.915	13.915	16.816	2.816	29.974
12/20/2004	8:31:53	9.4773	31.074	14.074	16.831	2.831	29.982
12/20/2004	8:32:27	10.0367	31.132	14.132	16.859	2.859	29.988
12/20/2004	8:33:02	10.6292	31.045	14.045	16.874	2.874	29.99
12/20/2004	8:33:40	11.2567	30.973	13.973	16.888	2.888	29.998
12/20/2004	8:34:20	11.9215	30.771	13.771	16.902	2.902	30.002
12/20/2004	8:35:02	12.6257	31.405	14.405	16.917	2.917	30.009
12/20/2004	8:35:47	13.3715	30.973	13.973	16.931	2.931	30.017
12/20/2004	8:36:34	14.1615	31.391	14.391	16.96	2.96	30.025
12/20/2004	8:37:24	14.9983	30.627	13.627	16.974	2.974	30.031
12/20/2004	8:38:18	15.8848	30.397	13.397	17.003	3.003	30.043
12/20/2004	8:39:14	16.8238	30.858	13.858	17.031	3.031	30.055
12/20/2004	8:40:14	17.8185	32.947	15.947	17.146	3.146	30.068
12/20/2004	8:41:17	18.8722	32.932	15.932	17.247	3.247	30.078
12/20/2004	8:42:24	19.9882	33.221	16.221	17.347	3.347	30.09
12/20/2004	8:43:35	21.1703	33.12	16.12	17.404	3.404	30.11

12/20/2004	8:44:50	22.4225	33.235	16.235	17.462	3.462	30.133
12/20/2004	8:46:09	23.749	33.091	16.091	17.519	3.519	30.145
12/20/2004	8:47:34	25.154	33.278	16.278	17.591	3.591	30.157
12/20/2004	8:49:03	26.6423	34.042	17.042	17.634	3.634	30.184
12/20/2004	8:50:38	28.2188	33.754	16.754	17.705	3.705	30.208
12/20/2004	8:52:18	29.8887	33.667	16.667	17.748	3.748	30.084
12/20/2004	8:54:04	31.6575	33.48	16.48	17.82	3.82	30.09
12/20/2004	8:55:56	33.5312	33.898	16.898	17.849	3.849	30.171
12/20/2004	8:57:55	35.5158	33.797	16.797	17.935	3.935	30.204
12/20/2004	8:59:55	37.5158	33.768	16.768	17.978	3.978	30.226
12/20/2004	9:01:55	39.5158	33.48	16.48	18.035	4.035	30.253
12/20/2004	9:03:55	41.5158	34.229	17.229	18.078	4.078	30.277
12/20/2004	9:05:55	43.5158	33.941	16.941	18.121	4.121	30.302
12/20/2004	9:07:55	45.5158	34.056	17.056	18.178	4.178	30.326
12/20/2004	9:09:55	47.5158	33.696	16.696	18.221	4.221	30.349
12/20/2004	9:11:55	49.5158	34.661	17.661	18.25	4.25	30.377
12/20/2004	9:13:55	51.5158	33.653	16.653	18.307	4.307	30.397
12/20/2004	9:15:55	53.5158	34.215	17.215	18.322	4.322	30.424
12/20/2004	9:17:55	55.5158	34.532	17.532	18.365	4.365	30.442
12/20/2004	9:19:55	57.5158	34.46	17.46	18.408	4.408	30.249
12/20/2004	9:21:55	59.5158	36.822	19.822	18.465	4.465	30.159
12/20/2004	9:23:55	61.5158	38.263	21.263	18.809	4.809	30.123
12/20/2004	9:25:55	63.5158	38.277	21.277	18.981	4.981	30.102
12/20/2004	9:27:55	65.5158	38.248	21.248	19.081	5.081	30.231
12/20/2004	9:29:55	67.5158	38.104	21.104	19.182	5.182	30.261
12/20/2004	9:31:55	69.5158	38.911	21.911	19.239	5.239	30.296
12/20/2004	9:33:55	71.5158	38.479	21.479	19.311	5.311	30.328
12/20/2004	9:35:55	73.5158	38.839	21.839	19.382	5.382	30.369
12/20/2004	9:37:55	75.5158	38.738	21.738	19.44	5.44	30.402
12/20/2004	9:39:55	77.5158	38.709	21.709	19.483	5.483	30.428
12/20/2004	9:41:55	79.5158	39.53	22.53	19.54	5.54	30.457
12/20/2004	9:43:55	81.5158	38.839	21.839	19.583	5.583	30.479
12/20/2004	9:45:55	83.5158	38.652	21.652	19.626	5.626	30.505
12/20/2004	9:47:55	85.5158	38.983	21.983	19.683	5.683	30.534
12/20/2004	9:49:55	87.5158	38.825	21.825	19.726	5.726	30.55
12/20/2004	9:51:55	89.5158	38.724	21.724	19.741	5.741	30.575
12/20/2004	9:53:55	91.5158	38.954	21.954	19.798	5.798	30.587
12/20/2004	9:55:55	93.5158	38.508	21.508	19.812	5.812	30.599
12/20/2004	9:57:55	95.5158	38.911	21.911	19.841	5.841	30.605
12/20/2004	9:59:55	97.5158	38.767	21.767	19.898	5.898	30.621
12/20/2004	10:01:55	99.5158	39.242	22.242	19.913	5.913	30.623
12/20/2004	10:03:55	101.5158	39.401	22.401	19.941	5.941	30.623
12/20/2004	10:05:55	103.5158	38.853	21.853	19.956	5.956	30.621
12/20/2004	10:07:55	105.5158	39.574	22.574	19.984	5.984	30.621
12/20/2004	10:09:55	107.5158	39.214	22.214	20.042	6.042	30.617
12/20/2004	10:11:55	109.5158	39.055	22.055	20.07	6.07	30.613
12/20/2004	10:13:55	111.5158	39.127	22.127	20.085	6.085	30.613
12/20/2004	10:15:55	113.5158	38.839	21.839	20.099	6.099	30.607
12/20/2004	10:17:55	115.5158	39.559	22.559	20.113	6.113	30.603
12/20/2004	10:19:55	117.5158	39.819	22.819	20.156	6.156	30.607
12/20/2004	10:21:55	119.5158	42.238	25.238	20.228	6.228	30.603
12/20/2004	10:23:55	121.5158	42.843	25.843	20.515	6.515	30.597

12/20/2004	10:25:55	123.5158	43.42	26.42	20.658	6.658	30.595
12/20/2004	10:27:55	125.5158	43.405	26.405	20.758	6.758	30.589
12/20/2004	10:29:55	127.5158	43.492	26.492	20.83	6.83	30.581
12/20/2004	10:31:55	129.5158	43.823	26.823	20.916	6.916	30.324
12/20/2004	10:33:55	131.5158	43.319	26.319	20.973	6.973	30.208
12/20/2004	10:35:55	133.5158	43.809	26.809	21.031	7.031	30.163
12/20/2004	10:37:55	135.5158	43.564	26.564	21.059	7.059	30.125
12/20/2004	10:39:55	137.5158	43.65	26.65	21.088	7.088	30.206
12/20/2004	10:41:55	139.5158	43.506	26.506	21.145	7.145	30.214
12/20/2004	10:43:55	141.5158	43.722	26.722	21.203	7.203	30.108
12/20/2004	10:45:55	143.5158	43.664	26.664	21.231	7.231	30.088
12/20/2004	10:47:55	145.5158	43.664	26.664	21.246	7.246	30.123
12/20/2004	10:49:55	147.5158	43.492	26.492	21.26	7.26	30.131
12/20/2004	10:51:55	149.5158	43.578	26.578	21.317	7.317	30.143
12/20/2004	10:53:55	151.5158	43.996	26.996	21.346	7.346	30.155
12/20/2004	10:55:55	153.5158	43.996	26.996	21.375	7.375	30.171
12/20/2004	10:57:55	155.5158	43.938	26.938	21.403	7.403	30.182
12/20/2004	10:59:55	157.5158	44.025	27.025	21.432	7.432	30.194
12/20/2004	11:01:55	159.5158	43.866	26.866	21.461	7.461	30.198
12/20/2004	11:03:55	161.5158	43.852	26.852	21.461	7.461	30.208
12/20/2004	11:05:55	163.5158	44.111	27.111	21.518	7.518	30.224
12/20/2004	11:07:55	165.5158	43.765	26.765	21.547	7.547	30.226
12/20/2004	11:09:55	167.5158	44.14	27.14	21.561	7.561	30.237
12/20/2004	11:11:55	169.5158	44.154	27.154	21.575	7.575	30.245
12/20/2004	11:13:55	171.5158	44.269	27.269	21.618	7.618	30.249
12/20/2004	11:15:55	173.5158	44.442	27.442	21.633	7.633	30.247
12/20/2004	11:17:55	175.5158	44.572	27.572	21.633	7.633	30.253
12/20/2004	11:19:55	177.5158	44.529	27.529	21.676	7.676	30.253
12/20/2004	11:21:55	179.5158	50.232	33.232	21.776	7.776	30.261
12/20/2004	11:23:55	181.5158	51.471	34.471	22.378	8.378	30.261
12/20/2004	11:25:55	183.5158	52.176	35.176	22.636	8.636	30.263
12/20/2004	11:27:55	185.5158	52.45	35.45	22.822	8.822	30.267
12/20/2004	11:29:55	187.5158	52.205	35.205	22.951	8.951	30.267
12/20/2004	11:31:55	189.5158	52.58	35.58	23.066	9.066	30.265
12/20/2004	11:33:55	191.5158	52.781	35.781	23.181	9.181	30.265
12/20/2004	11:35:55	193.5158	52.724	35.724	23.281	9.281	30.133
12/20/2004	11:37:55	195.5158	52.292	35.292	23.324	9.324	30.104
12/20/2004	11:39:55	197.5158	52.637	35.637	23.396	9.396	30.088
12/20/2004	11:41:55	199.5158	52.853	35.853	23.467	9.467	30.07
12/20/2004	11:43:55	201.5158	53.184	36.184	23.496	9.496	30.1
12/20/2004	11:45:55	203.5158	53.098	36.098	23.553	9.553	30.108
12/20/2004	11:47:55	205.5158	52.58	35.58	23.625	9.625	30.11
12/20/2004	11:49:55	207.5158	53.141	36.141	23.668	9.668	30.117
12/20/2004	11:51:55	209.5158	53.055	36.055	23.725	9.725	30.123
12/20/2004	11:53:55	211.5158	52.896	35.896	23.783	9.783	30.129
12/20/2004	11:55:55	213.5158	53.53	36.53	23.811	9.811	30.131
12/20/2004	11:57:55	215.5158	53.588	36.588	23.854	9.854	30.141
12/20/2004	11:59:55	217.5158	53.156	36.156	23.883	9.883	30.145
12/20/2004	12:01:55	219.5158	53.055	36.055	23.94	9.94	30.151
12/20/2004	12:03:55	221.5158	53.314	36.314	23.969	9.969	30.159
12/20/2004	12:05:55	223.5158	53.53	36.53	23.998	9.998	30.165
12/20/2004	12:07:55	225.5158	53.04	36.04	24.041	10.041	30.167



12/20/2004	12:09:55	227.5158	53.372	36.372	24.069	10.069	30.169
12/20/2004	12:11:55	229.5158	53.588	36.588	24.098	10.098	30.174
12/20/2004	12:13:55	231.5158	53.847	36.847	24.141	10.141	30.176
12/20/2004	12:15:55	233.5158	53.616	36.616	24.141	10.141	30.178
12/20/2004	12:17:55	235.5158	53.04	36.04	24.17	10.17	30.184
12/20/2004	12:19:55	237.5158	53.588	36.588	24.198	10.198	30.188
12/20/2004	12:21:55	239.5158	59.65	42.65	24.456	10.456	30.125
12/20/2004	12:23:55	241.5158	60.211	43.211	24.872	10.872	30.096
12/20/2004	12:25:55	243.5158	60.312	43.312	25.13	11.13	30.078
12/20/2004	12:27:55	245.5158	60.327	43.327	25.259	11.259	30.066
12/20/2004	12:29:55	247.5158	60.514	43.514	25.359	11.359	30.06
12/20/2004	12:31:55	249.5158	60.802	43.802	25.488	11.488	30.057
12/20/2004	12:33:55	251.5158	60.845	43.845	25.588	11.588	30.051
12/20/2004	12:35:55	253.5158	60.946	43.946	25.631	11.631	30.051
12/20/2004	12:37:55	255.5158	61.032	44.032	25.717	11.717	30.053
12/20/2004	12:39:55	257.5158	61.234	44.234	25.789	11.789	30.045
12/20/2004	12:41:55	259.5158	61.162	44.162	25.832	11.832	30.041
12/20/2004	12:43:55	261.5158	60.946	43.946	25.889	11.889	30.039
12/20/2004	12:45:55	263.5158	61.147	44.147	25.975	11.975	30.041
12/20/2004	12:47:55	265.5158	61.392	44.392	26.033	12.033	30.037
12/20/2004	12:49:55	267.5158	61.147	44.147	26.047	12.047	30.039
12/20/2004	12:51:55	269.5158	61.478	44.478	26.104	12.104	30.019
12/20/2004	12:53:55	271.5158	61.651	44.651	26.162	12.162	30.025
12/20/2004	12:55:55	273.5158	61.421	44.421	26.219	12.219	30.031
12/20/2004	12:57:55	275.5158	61.536	44.536	26.233	12.233	30.035
12/20/2004	12:59:55	277.5158	61.421	44.421	26.276	12.276	30.041
12/20/2004	13:01:55	279.5158	61.392	44.392	26.319	12.319	30.041
12/20/2004	13:03:55	281.5158	61.536	44.536	26.362	12.362	30.041
12/20/2004	13:05:55	283.5158	61.421	44.421	26.405	12.405	30.047
12/20/2004	13:07:55	285.5158	61.795	44.795	26.42	12.42	30.051
12/20/2004	13:09:55	287.5158	61.709	44.709	26.491	12.491	30.055
12/20/2004	13:11:55	289.5158	61.594	44.594	26.506	12.506	30.062
12/20/2004	13:13:55	291.5158	61.738	44.738	26.534	12.534	30.062
12/20/2004	13:15:55	293.5158	61.939	44.939	26.563	12.563	30.064
12/20/2004	13:17:55	295.5158	61.723	44.723	26.62	12.62	30.068
12/20/2004	13:19:55	297.5158	61.896	44.896	26.635	12.635	30.047
12/20/2004	13:21:55	299.5158	50.635	33.635	26.678	12.678	30.057

In-Situ Inc. Hermit 3000

Report generated: 1/11/2005 9:30:59  
Report from file: C:\Win-Situ\Data\SN45813 2004-12-21 072202 DARE PUMP .bin  
DataMgr Version 3.68

Serial number: 45813  
Firmware Version 7.1  
Unit name: HERMIT 3000

Test name: DARE PUMP

Test defined on: 12/17/2004 14:24:40  
Test started on: 12/21/2004 7:22:03  
Test stopped on: 12/22/2004 20:38:34  
Test extracted on: 1/7/2005 13:49:53

Data gathered using Logarithmic testing  
Maximum time between Minutes.  
Number of data samples 1205

TOTAL DATA SAMPLES 1205

Channel number [7]

Measurement type: Pressure  
Channel name: #7  
Linearity: 0.2503  
Scale: 99.8402  
Offset: -0.1892  
Warmup: 50  
Specific gravity: 1  
Mode: TOC  
User-defined reference: 17 Feet H2O  
Referenced on: channel definition.  
Pressure head at referenc 58.366 Feet H2O

Channel number [8]

Measurement type: Pressure  
Channel name: #8  
Linearity: 0.2257  
Scale: 99.3761  
Offset: -0.1631  
Warmup: 50  
Specific gravity: 1  
Mode: TOC  
User-defined reference: 14 Feet H2O  
Referenced on: channel definition.  
Pressure head at referenc 30.127 Feet H2O

Channel number [0]

Measurement type: Barometric Pressure  
Channel name: Barometric

Linearity: 0  
 Scale: 0  
 Offset: 0  
 Warmup: 50

Date	Time	Time	DTW #15	DD	DTW	TW#	DD	
-----	-----	minutes	feet	feet	feet	feet	feet	-----
12/21/2004	7:22:03	0	17.615	0.615	14.738	0.738	30.542	
12/21/2004	7:22:03	0.0162	17.658	0.658	14.738	0.738	30.54	
12/21/2004	7:22:04	0.0323	17.644	0.644	14.724	0.724	30.54	
12/21/2004	7:22:05	0.0485	37.398	20.398	14.738	0.738	30.542	
12/21/2004	7:22:06	0.0647	22.63	5.63	14.738	0.738	30.538	
12/21/2004	7:22:07	0.0808	24.489	7.489	14.738	0.738	30.54	
12/21/2004	7:22:08	0.097	27.054	10.054	14.738	0.738	30.54	
12/21/2004	7:22:09	0.1132	29.158	12.158	14.738	0.738	30.538	
12/21/2004	7:22:10	0.1293	31.42	14.42	14.738	0.738	30.538	
12/21/2004	7:22:11	0.1455	33.393	16.393	14.738	0.738	30.536	
12/21/2004	7:22:12	0.1617	35.439	18.439	14.738	0.738	30.536	
12/21/2004	7:22:13	0.1778	37.298	20.298	14.738	0.738	30.534	
12/21/2004	7:22:14	0.194	38.508	21.508	14.752	0.752	30.534	
12/21/2004	7:22:15	0.2102	39.991	22.991	14.752	0.752	30.534	
12/21/2004	7:22:16	0.2263	40.942	23.942	14.752	0.752	30.534	
12/21/2004	7:22:17	0.2425	41.317	24.317	14.767	0.767	30.536	
12/21/2004	7:22:18	0.2587	42.022	25.022	14.781	0.781	30.532	
12/21/2004	7:22:19	0.2748	42.93	25.93	14.795	0.795	30.532	
12/21/2004	7:22:20	0.291	43.549	26.549	14.81	0.81	30.532	
12/21/2004	7:22:21	0.3072	43.506	26.506	14.838	0.838	30.534	
12/21/2004	7:22:22	0.3233	44.154	27.154	14.853	0.853	30.532	
12/21/2004	7:22:23	0.34	44.918	27.918	14.881	0.881	30.532	
12/21/2004	7:22:24	0.3577	45.364	28.364	14.924	0.924	30.532	
12/21/2004	7:22:25	0.3763	45.883	28.883	14.953	0.953	30.532	
12/21/2004	7:22:26	0.3962	46.257	29.257	14.982	0.982	30.53	
12/21/2004	7:22:28	0.4172	46.214	29.214	15.039	1.039	30.53	
12/21/2004	7:22:29	0.4393	46.646	29.646	15.068	1.068	30.53	
12/21/2004	7:22:30	0.4628	46.891	29.891	15.125	1.125	30.53	
12/21/2004	7:22:32	0.4877	47.179	30.179	15.168	1.168	30.528	
12/21/2004	7:22:33	0.514	47.438	30.438	15.225	1.225	30.528	
12/21/2004	7:22:35	0.542	47.971	30.971	15.283	1.283	30.528	
12/21/2004	7:22:37	0.5717	47.741	30.741	15.34	1.34	30.526	
12/21/2004	7:22:39	0.603	48.043	31.043	15.397	1.397	30.528	
12/21/2004	7:22:41	0.6362	47.726	30.726	15.498	1.498	30.526	
12/21/2004	7:22:43	0.6713	47.611	30.611	15.569	1.569	30.526	
12/21/2004	7:22:45	0.7087	47.568	30.568	15.655	1.655	30.524	
12/21/2004	7:22:47	0.7482	47.352	30.352	15.741	1.741	30.522	
12/21/2004	7:22:50	0.79	47.164	30.164	15.827	1.827	30.522	
12/21/2004	7:22:53	0.8343	46.444	29.444	15.913	1.913	30.522	
12/21/2004	7:22:55	0.8813	46.804	29.804	15.999	1.999	30.52	
12/21/2004	7:22:58	0.9312	46.488	29.488	16.085	2.085	30.52	
12/21/2004	7:23:02	0.9838	46.055	29.055	16.171	2.171	30.518	
12/21/2004	7:23:05	1.0397	46.416	29.416	16.243	2.243	30.516	
12/21/2004	7:23:08	1.0988	46.214	29.214	16.343	2.343	30.516	

12/21/2004	7:23:12	1.1615	45.839	28.839	16.415	2.415	30.511
12/21/2004	7:23:16	1.2278	46.171	29.171	16.501	2.501	30.511
12/21/2004	7:23:20	1.2982	46.502	29.502	16.587	2.587	30.509
12/21/2004	7:23:25	1.3727	45.753	28.753	16.659	2.659	30.507
12/21/2004	7:23:30	1.4517	45.739	28.739	16.759	2.759	30.507
12/21/2004	7:23:35	1.5353	45.09	28.09	16.831	2.831	30.503
12/21/2004	7:23:40	1.6238	44.99	27.99	16.917	2.917	30.501
12/21/2004	7:23:46	1.7177	44.961	27.961	16.974	2.974	30.499
12/21/2004	7:23:52	1.817	44.874	27.874	17.046	3.046	30.497
12/21/2004	7:23:58	1.9223	42.08	25.08	17.117	3.117	30.495
12/21/2004	7:24:05	2.0338	40.668	23.668	17.204	3.204	30.493
12/21/2004	7:24:12	2.152	39.214	22.214	17.247	3.247	30.491
12/21/2004	7:24:19	2.2772	39.142	22.142	17.275	3.275	30.487
12/21/2004	7:24:27	2.4097	38.436	21.436	17.29	3.29	30.485
12/21/2004	7:24:36	2.5502	38.594	21.594	17.29	3.29	30.481
12/21/2004	7:24:44	2.699	38.335	21.335	17.318	3.318	30.479
12/21/2004	7:24:54	2.8565	38.076	21.076	17.333	3.333	30.475
12/21/2004	7:25:04	3.0233	38.32	21.32	17.347	3.347	30.581
12/21/2004	7:25:15	3.2002	38.839	21.839	17.361	3.361	30.632
12/21/2004	7:25:26	3.3875	38.897	21.897	17.39	3.39	30.654
12/21/2004	7:25:38	3.5858	38.781	21.781	17.433	3.433	30.67
12/21/2004	7:25:50	3.796	38.781	21.781	17.462	3.462	30.68
12/21/2004	7:26:04	4.0187	38.594	21.594	17.519	3.519	30.689
12/21/2004	7:26:18	4.2545	38.796	21.796	17.576	3.576	30.695
12/21/2004	7:26:33	4.5043	39.041	22.041	17.634	3.634	30.699
12/21/2004	7:26:49	4.769	38.897	21.897	17.677	3.677	30.705
12/21/2004	7:27:05	5.0493	38.796	21.796	17.734	3.734	30.711
12/21/2004	7:27:23	5.3462	39.358	22.358	17.777	3.777	30.717
12/21/2004	7:27:42	5.6607	39.401	22.401	17.849	3.849	30.674
12/21/2004	7:28:02	5.9938	39.631	22.631	17.906	3.906	30.503
12/21/2004	7:28:23	6.3467	39.703	22.703	17.963	3.963	30.481
12/21/2004	7:28:46	6.7205	39.574	22.574	18.021	4.021	30.469
12/21/2004	7:29:09	7.1165	39.732	22.732	18.092	4.092	30.461
12/21/2004	7:29:35	7.5358	39.862	22.862	18.135	4.135	30.452
12/21/2004	7:30:01	7.9802	39.934	22.934	18.221	4.221	30.444
12/21/2004	7:30:30	8.4508	39.3	22.3	18.279	4.279	30.481
12/21/2004	7:30:59	8.9493	39.977	22.977	18.35	4.35	30.593
12/21/2004	7:31:31	9.4773	39.574	22.574	18.408	4.408	30.615
12/21/2004	7:32:05	10.0367	39.545	22.545	18.465	4.465	30.63
12/21/2004	7:32:40	10.6292	39.833	22.833	18.537	4.537	30.64
12/21/2004	7:33:18	11.2567	40.035	23.035	18.608	4.608	30.646
12/21/2004	7:33:58	11.9215	39.905	22.905	18.68	4.68	30.654
12/21/2004	7:34:40	12.6257	40.38	23.38	18.752	4.752	30.662
12/21/2004	7:35:25	13.3715	40.38	23.38	18.823	4.823	30.668
12/21/2004	7:36:12	14.1615	40.582	23.582	18.895	4.895	30.676
12/21/2004	7:37:02	14.9983	40.553	23.553	18.967	4.967	30.685
12/21/2004	7:37:56	15.8848	40.553	23.553	19.038	5.038	30.693
12/21/2004	7:38:52	16.8238	40.294	23.294	19.124	5.124	30.705
12/21/2004	7:39:52	17.8185	40.712	23.712	19.196	5.196	30.713
12/21/2004	7:40:55	18.8722	40.222	23.222	19.268	5.268	30.721
12/21/2004	7:42:02	19.9882	40.928	23.928	19.354	5.354	30.731
12/21/2004	7:43:13	21.1703	41.014	24.014	19.425	5.425	30.742

12/21/2004	7:44:28	22.4225	41.014	24.014	19.511	5.511	30.752
12/21/2004	7:45:47	23.749	42.383	25.383	19.597	5.597	30.76
12/21/2004	7:47:12	25.154	43.074	26.074	19.784	5.784	30.475
12/21/2004	7:48:41	26.6423	42.786	25.786	19.941	5.941	30.444
12/21/2004	7:50:16	28.2188	43.967	26.967	20.027	6.027	30.544
12/21/2004	7:51:56	29.8887	43.448	26.448	20.156	6.156	30.587
12/21/2004	7:53:42	31.6575	43.636	26.636	20.257	6.257	30.605
12/21/2004	7:55:34	33.5312	43.42	26.42	20.386	6.386	30.619
12/21/2004	7:57:33	35.5158	43.304	26.304	20.5	6.5	30.432
12/21/2004	7:59:33	37.5158	43.837	26.837	20.572	6.572	30.516
12/21/2004	8:01:33	39.5158	44.125	27.125	20.701	6.701	30.377
12/21/2004	8:03:33	41.5158	44.226	27.226	20.787	6.787	30.467
12/21/2004	8:05:33	43.5158	44.485	27.485	20.873	6.873	30.479
12/21/2004	8:07:33	45.5158	44.097	27.097	20.959	6.959	30.489
12/21/2004	8:09:33	47.5158	44.37	27.37	21.031	7.031	30.493
12/21/2004	8:11:33	49.5158	44.413	27.413	21.117	7.117	30.369
12/21/2004	8:13:33	51.5158	44.485	27.485	21.174	7.174	30.395
12/21/2004	8:15:33	53.5158	45.177	28.177	21.246	7.246	30.41
12/21/2004	8:17:33	55.5158	44.802	27.802	21.317	7.317	30.414
12/21/2004	8:19:33	57.5158	44.831	27.831	21.375	7.375	30.414
12/21/2004	8:21:33	59.5158	45.105	28.105	21.446	7.446	30.418
12/21/2004	8:23:33	61.5158	45.321	28.321	21.504	7.504	30.414
12/21/2004	8:25:33	63.5158	44.817	27.817	21.561	7.561	30.412
12/21/2004	8:27:33	65.5158	45.062	28.062	21.604	7.604	30.412
12/21/2004	8:29:33	67.5158	45.306	28.306	21.676	7.676	30.41
12/21/2004	8:31:33	69.5158	45.162	28.162	21.719	7.719	30.402
12/21/2004	8:33:33	71.5158	45.191	28.191	21.79	7.79	30.402
12/21/2004	8:35:33	73.5158	45.105	28.105	21.833	7.833	30.395
12/21/2004	8:37:33	75.5158	45.479	28.479	21.876	7.876	30.389
12/21/2004	8:39:33	77.5158	44.889	27.889	21.934	7.934	30.385
12/21/2004	8:41:33	79.5158	45.479	28.479	21.977	7.977	30.379
12/21/2004	8:43:33	81.5158	45.191	28.191	22.02	8.02	30.373
12/21/2004	8:45:33	83.5158	45.537	28.537	22.063	8.063	30.365
12/21/2004	8:47:33	85.5158	45.393	28.393	22.12	8.12	30.332
12/21/2004	8:49:33	87.5158	45.983	28.983	22.163	8.163	30.32
12/21/2004	8:51:33	89.5158	45.854	28.854	22.192	8.192	30.308
12/21/2004	8:53:33	91.5158	45.926	28.926	22.22	8.22	30.308
12/21/2004	8:55:33	93.5158	45.911	28.911	22.249	8.249	30.31
12/21/2004	8:57:33	95.5158	45.335	28.335	22.306	8.306	30.308
12/21/2004	8:59:33	97.5158	45.652	28.652	22.335	8.335	30.306
12/21/2004	9:01:33	99.5158	45.681	28.681	22.364	8.364	30.302
12/21/2004	9:03:33	101.5158	45.897	28.897	22.421	8.421	30.3
12/21/2004	9:05:33	103.5158	45.767	28.767	22.45	8.45	30.302
12/21/2004	9:07:33	105.5158	45.35	28.35	22.493	8.493	30.298
12/21/2004	9:09:33	107.5158	45.825	28.825	22.521	8.521	30.298
12/21/2004	9:11:33	109.5158	46.358	29.358	22.55	8.55	30.3
12/21/2004	9:13:33	111.5158	46.041	29.041	22.593	8.593	30.3
12/21/2004	9:15:33	113.5158	45.595	28.595	22.636	8.636	30.3
12/21/2004	9:17:33	115.5158	45.782	28.782	22.665	8.665	30.298
12/21/2004	9:19:33	117.5158	45.839	28.839	22.693	8.693	30.296
12/21/2004	9:21:33	119.5158	46.012	29.012	22.736	8.736	30.292
12/21/2004	9:23:33	121.5158	46.401	29.401	22.751	8.751	30.294

12/21/2004	9:25:33	123.5158	46.027	29.027	22.779	8.779	30.292
12/21/2004	9:27:33	125.5158	45.955	28.955	22.822	8.822	30.288
12/21/2004	9:29:33	127.5158	46.3	29.3	22.851	8.851	30.286
12/21/2004	9:31:33	129.5158	45.94	28.94	22.851	8.851	30.286
12/21/2004	9:33:33	131.5158	46.257	29.257	22.88	8.88	30.283
12/21/2004	9:35:33	133.5158	46.271	29.271	22.923	8.923	30.286
12/21/2004	9:37:33	135.5158	46.761	29.761	22.951	8.951	30.283
12/21/2004	9:39:33	137.5158	46.502	29.502	22.98	8.98	30.283
12/21/2004	9:41:33	139.5158	46.257	29.257	22.994	8.994	30.283
12/21/2004	9:43:33	141.5158	46.315	29.315	23.009	9.009	30.277
12/21/2004	9:45:33	143.5158	46.387	29.387	23.037	9.037	30.279
12/21/2004	9:47:33	145.5158	46.632	29.632	23.066	9.066	30.277
12/21/2004	9:49:33	147.5158	45.983	28.983	23.095	9.095	30.275
12/21/2004	9:51:33	149.5158	46.531	29.531	23.123	9.123	30.277
12/21/2004	9:53:33	151.5158	46.905	29.905	23.152	9.152	30.275
12/21/2004	9:55:33	153.5158	46.79	29.79	23.166	9.166	30.275
12/21/2004	9:57:33	155.5158	46.488	29.488	23.195	9.195	30.277
12/21/2004	9:59:33	157.5158	46.603	29.603	23.224	9.224	30.277
12/21/2004	10:01:33	159.5158	46.56	29.56	23.238	9.238	30.275
12/21/2004	10:03:33	161.5158	46.588	29.588	23.267	9.267	30.271
12/21/2004	10:05:33	163.5158	46.689	29.689	23.295	9.295	30.271
12/21/2004	10:07:33	165.5158	46.79	29.79	23.324	9.324	30.271
12/21/2004	10:09:33	167.5158	46.617	29.617	23.338	9.338	30.273
12/21/2004	10:11:33	169.5158	46.776	29.776	23.367	9.367	30.316
12/21/2004	10:13:33	171.5158	47.035	30.035	23.396	9.396	30.314
12/21/2004	10:15:33	173.5158	46.977	29.977	23.396	9.396	30.271
12/21/2004	10:17:33	175.5158	47.337	30.337	23.424	9.424	30.271
12/21/2004	10:19:33	177.5158	46.531	29.531	23.453	9.453	30.273
12/21/2004	10:21:33	179.5158	46.862	29.862	23.467	9.467	30.275
12/21/2004	10:23:33	181.5158	46.704	29.704	23.482	9.482	30.275
12/21/2004	10:25:33	183.5158	46.848	29.848	23.496	9.496	30.273
12/21/2004	10:27:33	185.5158	46.819	29.819	23.525	9.525	30.275
12/21/2004	10:29:33	187.5158	46.92	29.92	23.539	9.539	30.273
12/21/2004	10:31:33	189.5158	46.804	29.804	23.553	9.553	30.275
12/21/2004	10:33:33	191.5158	46.862	29.862	23.582	9.582	30.275
12/21/2004	10:35:33	193.5158	46.545	29.545	23.611	9.611	30.275
12/21/2004	10:37:33	195.5158	46.632	29.632	23.611	9.611	30.273
12/21/2004	10:39:33	197.5158	46.905	29.905	23.625	9.625	30.275
12/21/2004	10:41:33	199.5158	47.236	30.236	23.654	9.654	30.275
12/21/2004	10:43:33	201.5158	46.992	29.992	23.668	9.668	30.271
12/21/2004	10:45:33	203.5158	47.092	30.092	23.668	9.668	30.275
12/21/2004	10:47:33	205.5158	47.107	30.107	23.682	9.682	30.273
12/21/2004	10:49:33	207.5158	47.02	30.02	23.697	9.697	30.271
12/21/2004	10:51:33	209.5158	46.718	29.718	23.711	9.711	30.271
12/21/2004	10:53:33	211.5158	46.833	29.833	23.725	9.725	30.271
12/21/2004	10:55:33	213.5158	46.704	29.704	23.74	9.74	30.271
12/21/2004	10:57:33	215.5158	46.948	29.948	23.768	9.768	30.271
12/21/2004	10:59:33	217.5158	47.193	30.193	23.768	9.768	30.269
12/21/2004	11:01:33	219.5158	46.819	29.819	23.783	9.783	30.269
12/21/2004	11:03:33	221.5158	46.992	29.992	23.797	9.797	30.267
12/21/2004	11:05:33	223.5158	47.683	30.683	23.826	9.826	30.265
12/21/2004	11:07:33	225.5158	46.934	29.934	23.826	9.826	30.263

12/21/2004	11:09:33	227.5158	47.683	30.683	23.84	9.84	30.261
12/21/2004	11:11:33	229.5158	47.179	30.179	23.869	9.869	30.261
12/21/2004	11:13:33	231.5158	47.222	30.222	23.883	9.883	30.261
12/21/2004	11:15:33	233.5158	47.222	30.222	23.883	9.883	30.257
12/21/2004	11:17:33	235.5158	46.992	29.992	23.897	9.897	30.257
12/21/2004	11:19:33	237.5158	46.934	29.934	23.912	9.912	30.257
12/21/2004	11:21:33	239.5158	47.38	30.38	23.912	9.912	30.255
12/21/2004	11:23:33	241.5158	47.741	30.741	23.94	9.94	30.253
12/21/2004	11:25:33	243.5158	47.121	30.121	23.94	9.94	30.253
12/21/2004	11:27:33	245.5158	47.337	30.337	23.955	9.955	30.251
12/21/2004	11:29:33	247.5158	47.193	30.193	23.969	9.969	30.249
12/21/2004	11:31:33	249.5158	47.942	30.942	23.969	9.969	30.249
12/21/2004	11:33:33	251.5158	47.424	30.424	23.983	9.983	30.247
12/21/2004	11:35:33	253.5158	47.568	30.568	23.998	9.998	30.247
12/21/2004	11:37:33	255.5158	47.179	30.179	24.012	10.012	30.243
12/21/2004	11:39:33	257.5158	47.164	30.164	24.026	10.026	30.243
12/21/2004	11:41:33	259.5158	47.236	30.236	24.041	10.041	30.241
12/21/2004	11:43:33	261.5158	47.236	30.236	24.055	10.055	30.241
12/21/2004	11:45:33	263.5158	47.265	30.265	24.069	10.069	30.239
12/21/2004	11:47:33	265.5158	47.294	30.294	24.069	10.069	30.237
12/21/2004	11:49:33	267.5158	47.323	30.323	24.084	10.084	30.235
12/21/2004	11:51:33	269.5158	47.64	30.64	24.098	10.098	30.261
12/21/2004	11:53:33	271.5158	47.453	30.453	24.112	10.112	30.251
12/21/2004	11:55:33	273.5158	47.38	30.38	24.112	10.112	30.226
12/21/2004	11:57:33	275.5158	47.582	30.582	24.112	10.112	30.226
12/21/2004	11:59:33	277.5158	47.741	30.741	24.112	10.112	30.226
12/21/2004	12:01:33	279.5158	48.029	31.029	24.127	10.127	30.228
12/21/2004	12:03:33	281.5158	47.784	30.784	24.141	10.141	30.228
12/21/2004	12:05:33	283.5158	47.496	30.496	24.155	10.155	30.226
12/21/2004	12:07:33	285.5158	47.726	30.726	24.155	10.155	30.224
12/21/2004	12:09:33	287.5158	47.51	30.51	24.184	10.184	30.224
12/21/2004	12:11:33	289.5158	47.467	30.467	24.184	10.184	30.22
12/21/2004	12:13:33	291.5158	47.625	30.625	24.198	10.198	30.218
12/21/2004	12:15:33	293.5158	47.467	30.467	24.198	10.198	30.218
12/21/2004	12:17:33	295.5158	47.885	30.885	24.198	10.198	30.22
12/21/2004	12:19:33	297.5158	47.568	30.568	24.227	10.227	30.216
12/21/2004	12:21:33	299.5158	47.337	30.337	24.241	10.241	30.218
12/21/2004	12:23:33	301.5158	47.28	30.28	24.241	10.241	30.218
12/21/2004	12:25:33	303.5158	47.424	30.424	24.256	10.256	30.214
12/21/2004	12:27:33	305.5158	47.625	30.625	24.256	10.256	30.212
12/21/2004	12:29:33	307.5158	47.265	30.265	24.256	10.256	30.212
12/21/2004	12:31:33	309.5158	48.101	31.101	24.27	10.27	30.208
12/21/2004	12:33:33	311.5158	47.496	30.496	24.27	10.27	30.204
12/21/2004	12:35:33	313.5158	47.784	30.784	24.284	10.284	30.206
12/21/2004	12:37:33	315.5158	47.294	30.294	24.284	10.284	30.204
12/21/2004	12:39:33	317.5158	47.841	30.841	24.299	10.299	30.204
12/21/2004	12:41:33	319.5158	47.654	30.654	24.313	10.313	30.2
12/21/2004	12:43:33	321.5158	47.683	30.683	24.313	10.313	30.2
12/21/2004	12:45:33	323.5158	47.726	30.726	24.313	10.313	30.2
12/21/2004	12:47:33	325.5158	48.029	31.029	24.313	10.313	30.196
12/21/2004	12:49:33	327.5158	47.755	30.755	24.327	10.327	30.198
12/21/2004	12:51:33	329.5158	47.38	30.38	24.327	10.327	30.198

12/21/2004	12:53:33	331.5158	47.726	30.726	24.356	10.356	30.2
12/21/2004	12:55:33	333.5158	47.525	30.525	24.356	10.356	30.196
12/21/2004	12:57:33	335.5158	47.755	30.755	24.356	10.356	30.196
12/21/2004	12:59:33	337.5158	47.424	30.424	24.356	10.356	30.196
12/21/2004	13:01:33	339.5158	47.87	30.87	24.342	10.342	30.196
12/21/2004	13:03:33	341.5158	47.769	30.769	24.356	10.356	30.196
12/21/2004	13:05:33	343.5158	47.813	30.813	24.37	10.37	30.194
12/21/2004	13:07:33	345.5158	47.64	30.64	24.385	10.385	30.196
12/21/2004	13:09:33	347.5158	47.712	30.712	24.385	10.385	30.194
12/21/2004	13:11:33	349.5158	47.669	30.669	24.385	10.385	30.196
12/21/2004	13:13:33	351.5158	47.553	30.553	24.385	10.385	30.196
12/21/2004	13:15:33	353.5158	48.072	31.072	24.399	10.399	30.194
12/21/2004	13:17:33	355.5158	47.798	30.798	24.399	10.399	30.196
12/21/2004	13:19:33	357.5158	47.957	30.957	24.399	10.399	30.196
12/21/2004	13:21:33	359.5158	47.467	30.467	24.413	10.413	30.194
12/21/2004	13:23:33	361.5158	47.741	30.741	24.413	10.413	30.194
12/21/2004	13:25:33	363.5158	47.611	30.611	24.413	10.413	30.194
12/21/2004	13:27:33	365.5158	47.611	30.611	24.413	10.413	30.192
12/21/2004	13:29:33	367.5158	47.64	30.64	24.428	10.428	30.192
12/21/2004	13:31:33	369.5158	47.712	30.712	24.442	10.442	30.192
12/21/2004	13:33:33	371.5158	47.683	30.683	24.428	10.428	30.192
12/21/2004	13:35:33	373.5158	47.611	30.611	24.442	10.442	30.19
12/21/2004	13:37:33	375.5158	47.798	30.798	24.442	10.442	30.19
12/21/2004	13:39:33	377.5158	47.424	30.424	24.456	10.456	30.192
12/21/2004	13:41:33	379.5158	48.187	31.187	24.456	10.456	30.19
12/21/2004	13:43:33	381.5158	48.072	31.072	24.456	10.456	30.188
12/21/2004	13:45:33	383.5158	47.741	30.741	24.456	10.456	30.186
12/21/2004	13:47:33	385.5158	47.971	30.971	24.485	10.485	30.188
12/21/2004	13:49:33	387.5158	47.712	30.712	24.471	10.471	30.188
12/21/2004	13:51:33	389.5158	47.957	30.957	24.485	10.485	30.184
12/21/2004	13:53:33	391.5158	47.769	30.769	24.485	10.485	30.186
12/21/2004	13:55:33	393.5158	47.899	30.899	24.485	10.485	30.184
12/21/2004	13:57:33	395.5158	48.014	31.014	24.485	10.485	30.18
12/21/2004	13:59:33	397.5158	47.769	30.769	24.499	10.499	30.182
12/21/2004	14:01:33	399.5158	47.769	30.769	24.499	10.499	30.182
12/21/2004	14:03:33	401.5158	47.942	30.942	24.499	10.499	30.18
12/21/2004	14:05:33	403.5158	47.611	30.611	24.514	10.514	30.184
12/21/2004	14:07:33	405.5158	47.769	30.769	24.514	10.514	30.182
12/21/2004	14:09:33	407.5158	47.496	30.496	24.514	10.514	30.184
12/21/2004	14:11:33	409.5158	47.424	30.424	24.514	10.514	30.182
12/21/2004	14:13:33	411.5158	48.115	31.115	24.528	10.528	30.182
12/21/2004	14:15:33	413.5158	48.302	31.302	24.528	10.528	30.18
12/21/2004	14:17:33	415.5158	48.129	31.129	24.528	10.528	30.182
12/21/2004	14:19:33	417.5158	47.813	30.813	24.528	10.528	30.18
12/21/2004	14:21:33	419.5158	48	31	24.542	10.542	30.184
12/21/2004	14:23:33	421.5158	47.942	30.942	24.542	10.542	30.182
12/21/2004	14:25:33	423.5158	47.87	30.87	24.528	10.528	30.182
12/21/2004	14:27:33	425.5158	47.899	30.899	24.542	10.542	30.182
12/21/2004	14:29:33	427.5158	47.827	30.827	24.528	10.528	30.18
12/21/2004	14:31:33	429.5158	48.072	31.072	24.542	10.542	30.182
12/21/2004	14:33:33	431.5158	48	31	24.542	10.542	30.184
12/21/2004	14:35:33	433.5158	48.158	31.158	24.557	10.557	30.184



12/21/2004	14:37:33	435.5158	48.144	31.144	24.557	10.557	30.184
12/21/2004	14:39:33	437.5158	49.426	32.426	24.614	10.614	30.204
12/21/2004	14:41:33	439.5158	49.498	32.498	24.743	10.743	30.194
12/21/2004	14:43:33	441.5158	50.29	33.29	24.786	10.786	30.174
12/21/2004	14:45:33	443.5158	49.67	32.67	24.829	10.829	30.176
12/21/2004	14:47:33	445.5158	49.8	32.8	24.858	10.858	30.18
12/21/2004	14:49:33	447.5158	49.728	32.728	24.901	10.901	30.18
12/21/2004	14:51:33	449.5158	49.858	32.858	24.915	10.915	30.18
12/21/2004	14:53:33	451.5158	50.045	33.045	24.944	10.944	30.182
12/21/2004	14:55:33	453.5158	50.362	33.362	24.958	10.958	30.182
12/21/2004	14:57:33	455.5158	49.728	32.728	24.972	10.972	30.184
12/21/2004	14:59:33	457.5158	50.203	33.203	24.987	10.987	30.184
12/21/2004	15:01:33	459.5158	50.29	33.29	25.001	11.001	30.188
12/21/2004	15:03:33	461.5158	49.958	32.958	25.03	11.03	30.186
12/21/2004	15:05:33	463.5158	50.203	33.203	25.03	11.03	30.184
12/21/2004	15:07:33	465.5158	50.275	33.275	25.044	11.044	30.184
12/21/2004	15:09:33	467.5158	50.16	33.16	25.058	11.058	30.184
12/21/2004	15:11:33	469.5158	50.405	33.405	25.073	11.073	30.182
12/21/2004	15:13:33	471.5158	50.175	33.175	25.087	11.087	30.184
12/21/2004	15:15:33	473.5158	50.189	33.189	25.087	11.087	30.184
12/21/2004	15:17:33	475.5158	50.261	33.261	25.101	11.101	30.184
12/21/2004	15:19:33	477.5158	50.319	33.319	25.101	11.101	30.184
12/21/2004	15:21:33	479.5158	50.592	33.592	25.116	11.116	30.186
12/21/2004	15:23:33	481.5158	50.477	33.477	25.144	11.144	30.184
12/21/2004	15:25:33	483.5158	49.714	32.714	25.159	11.159	30.184
12/21/2004	15:27:33	485.5158	50.074	33.074	25.159	11.159	30.184
12/21/2004	15:29:33	487.5158	50.074	33.074	25.173	11.173	30.186
12/21/2004	15:31:33	489.5158	50.117	33.117	25.187	11.187	30.186
12/21/2004	15:33:33	491.5158	49.915	32.915	25.187	11.187	30.186
12/21/2004	15:35:33	493.5158	50.549	33.549	25.202	11.202	30.184
12/21/2004	15:37:33	495.5158	50.347	33.347	25.216	11.216	30.184
12/21/2004	15:39:33	497.5158	50.376	33.376	25.23	11.23	30.18
12/21/2004	15:41:33	499.5158	50.563	33.563	25.23	11.23	30.18
12/21/2004	15:43:33	501.5158	49.858	32.858	25.23	11.23	30.182
12/21/2004	15:45:33	503.5158	50.16	33.16	25.259	11.259	30.182
12/21/2004	15:47:33	505.5158	50.434	33.434	25.259	11.259	30.182
12/21/2004	15:49:33	507.5158	50.405	33.405	25.273	11.273	30.212
12/21/2004	15:51:33	509.5158	50.232	33.232	25.288	11.288	30.202
12/21/2004	15:53:33	511.5158	49.958	32.958	25.288	11.288	30.18
12/21/2004	15:55:33	513.5158	50.117	33.117	25.302	11.302	30.182
12/21/2004	15:57:33	515.5158	50.002	33.002	25.302	11.302	30.184
12/21/2004	15:59:33	517.5158	50.347	33.347	25.316	11.316	30.19
12/21/2004	16:01:33	519.5158	50.362	33.362	25.331	11.331	30.19
12/21/2004	16:03:33	521.5158	49.901	32.901	25.331	11.331	30.19
12/21/2004	16:05:33	523.5158	50.304	33.304	25.345	11.345	30.19
12/21/2004	16:07:33	525.5158	50.506	33.506	25.345	11.345	30.19
12/21/2004	16:09:33	527.5158	50.117	33.117	25.359	11.359	30.19
12/21/2004	16:11:33	529.5158	50.376	33.376	25.374	11.374	30.192
12/21/2004	16:13:33	531.5158	49.973	32.973	25.388	11.388	30.194
12/21/2004	16:15:33	533.5158	50.592	33.592	25.388	11.388	30.192
12/21/2004	16:17:33	535.5158	50.29	33.29	25.388	11.388	30.196
12/21/2004	16:19:33	537.5158	50.376	33.376	25.402	11.402	30.196

12/21/2004	16:21:33	539.5158	50.419	33.419	25.416	11.416	30.196
12/21/2004	16:23:33	541.5158	50.607	33.607	25.445	11.445	30.198
12/21/2004	16:25:33	543.5158	50.491	33.491	25.445	11.445	30.198
12/21/2004	16:27:33	545.5158	50.938	33.938	25.459	11.459	30.2
12/21/2004	16:29:33	547.5158	50.319	33.319	25.459	11.459	30.2
12/21/2004	16:31:33	549.5158	50.391	33.391	25.488	11.488	30.198
12/21/2004	16:33:33	551.5158	50.578	33.578	25.488	11.488	30.196
12/21/2004	16:35:33	553.5158	51.067	34.067	25.502	11.502	30.196
12/21/2004	16:37:33	555.5158	50.506	33.506	25.502	11.502	30.198
12/21/2004	16:39:33	557.5158	50.203	33.203	25.517	11.517	30.196
12/21/2004	16:41:33	559.5158	50.549	33.549	25.517	11.517	30.194
12/21/2004	16:43:33	561.5158	50.477	33.477	25.56	11.56	30.198
12/21/2004	16:45:33	563.5158	50.707	33.707	25.56	11.56	30.196
12/21/2004	16:47:33	565.5158	50.535	33.535	25.574	11.574	30.196
12/21/2004	16:49:33	567.5158	50.664	33.664	25.574	11.574	30.196
12/21/2004	16:51:33	569.5158	50.607	33.607	25.588	11.588	30.198
12/21/2004	16:53:33	571.5158	50.607	33.607	25.588	11.588	30.198
12/21/2004	16:55:33	573.5158	50.463	33.463	25.603	11.603	30.198
12/21/2004	16:57:33	575.5158	50.448	33.448	25.617	11.617	30.198
12/21/2004	16:59:33	577.5158	50.693	33.693	25.631	11.631	30.198
12/21/2004	17:01:33	579.5158	50.851	33.851	25.646	11.646	30.196
12/21/2004	17:03:33	581.5158	50.938	33.938	25.646	11.646	30.2
12/21/2004	17:05:33	583.5158	50.679	33.679	25.674	11.674	30.196
12/21/2004	17:07:33	585.5158	50.391	33.391	25.689	11.689	30.196
12/21/2004	17:09:33	587.5158	50.29	33.29	25.703	11.703	30.198
12/21/2004	17:11:33	589.5158	50.635	33.635	25.703	11.703	30.194
12/21/2004	17:13:33	591.5158	50.664	33.664	25.717	11.717	30.198
12/21/2004	17:15:33	593.5158	50.88	33.88	25.732	11.732	30.198
12/21/2004	17:17:33	595.5158	50.895	33.895	25.732	11.732	30.2
12/21/2004	17:19:33	597.5158	50.707	33.707	25.732	11.732	30.198
12/21/2004	17:21:33	599.5158	50.635	33.635	25.746	11.746	30.2
12/21/2004	17:23:33	601.5158	50.823	33.823	25.746	11.746	30.198
12/21/2004	17:25:33	603.5158	50.65	33.65	25.76	11.76	30.196
12/21/2004	17:27:33	605.5158	50.549	33.549	25.775	11.775	30.198
12/21/2004	17:29:33	607.5158	50.635	33.635	25.789	11.789	30.198
12/21/2004	17:31:33	609.5158	50.765	33.765	25.818	11.818	30.198
12/21/2004	17:33:33	611.5158	50.837	33.837	25.832	11.832	30.198
12/21/2004	17:35:33	613.5158	50.621	33.621	25.832	11.832	30.198
12/21/2004	17:37:33	615.5158	50.938	33.938	25.832	11.832	30.198
12/21/2004	17:39:33	617.5158	50.952	33.952	25.832	11.832	30.198
12/21/2004	17:41:33	619.5158	50.736	33.736	25.861	11.861	30.198
12/21/2004	17:43:33	621.5158	51.01	34.01	25.861	11.861	30.198
12/21/2004	17:45:33	623.5158	50.765	33.765	25.875	11.875	30.202
12/21/2004	17:47:33	625.5158	51.024	34.024	25.889	11.889	30.2
12/21/2004	17:49:33	627.5158	50.549	33.549	25.904	11.904	30.202
12/21/2004	17:51:33	629.5158	50.823	33.823	25.889	11.889	30.2
12/21/2004	17:53:33	631.5158	51.139	34.139	25.918	11.918	30.2
12/21/2004	17:55:33	633.5158	50.808	33.808	25.932	11.932	30.202
12/21/2004	17:57:33	635.5158	51.211	34.211	25.932	11.932	30.198
12/21/2004	17:59:33	637.5158	51.125	34.125	25.947	11.947	30.2
12/21/2004	18:01:33	639.5158	51.168	34.168	25.947	11.947	30.198
12/21/2004	18:03:33	641.5158	50.794	33.794	25.961	11.961	30.2

12/21/2004	18:05:33	643.5158	50.794	33.794	25.99	11.99	30.202
12/21/2004	18:07:33	645.5158	51.01	34.01	25.99	11.99	30.2
12/21/2004	18:09:33	647.5158	51.168	34.168	26.004	12.004	30.204
12/21/2004	18:11:33	649.5158	50.808	33.808	26.018	12.018	30.202
12/21/2004	18:13:33	651.5158	50.938	33.938	26.018	12.018	30.204
12/21/2004	18:15:33	653.5158	51.111	34.111	26.033	12.033	30.204
12/21/2004	18:17:33	655.5158	51.226	34.226	26.061	12.061	30.245
12/21/2004	18:19:33	657.5158	51.715	34.715	26.061	12.061	30.243
12/21/2004	18:21:33	659.5158	50.851	33.851	26.047	12.047	30.202
12/21/2004	18:23:33	661.5158	50.938	33.938	26.076	12.076	30.202
12/21/2004	18:25:33	663.5158	51.053	34.053	26.09	12.09	30.202
12/21/2004	18:27:33	665.5158	50.851	33.851	26.104	12.104	30.204
12/21/2004	18:29:33	667.5158	51.197	34.197	26.119	12.119	30.204
12/21/2004	18:31:33	669.5158	50.765	33.765	26.119	12.119	30.206
12/21/2004	18:33:33	671.5158	51.082	34.082	26.133	12.133	30.206
12/21/2004	18:35:33	673.5158	51.067	34.067	26.147	12.147	30.206
12/21/2004	18:37:33	675.5158	51.053	34.053	26.162	12.162	30.204
12/21/2004	18:39:33	677.5158	50.837	33.837	26.176	12.176	30.206
12/21/2004	18:41:33	679.5158	51.499	34.499	26.176	12.176	30.206
12/21/2004	18:43:33	681.5158	51.543	34.543	26.19	12.19	30.208
12/21/2004	18:45:33	683.5158	51.053	34.053	26.19	12.19	30.21
12/21/2004	18:47:33	685.5158	51.01	34.01	26.205	12.205	30.212
12/21/2004	18:49:33	687.5158	51.283	34.283	26.219	12.219	30.212
12/21/2004	18:51:33	689.5158	51.931	34.931	26.233	12.233	30.212
12/21/2004	18:53:33	691.5158	50.923	33.923	26.248	12.248	30.214
12/21/2004	18:55:33	693.5158	51.37	34.37	26.248	12.248	30.216
12/21/2004	18:57:33	695.5158	50.981	33.981	26.262	12.262	30.218
12/21/2004	18:59:33	697.5158	51.211	34.211	26.291	12.291	30.218
12/21/2004	19:01:33	699.5158	51.427	34.427	26.291	12.291	30.214
12/21/2004	19:03:33	701.5158	51.154	34.154	26.305	12.305	30.22
12/21/2004	19:05:33	703.5158	51.269	34.269	26.305	12.305	30.218
12/21/2004	19:07:33	705.5158	50.995	33.995	26.319	12.319	30.22
12/21/2004	19:09:33	707.5158	51.255	34.255	26.319	12.319	30.22
12/21/2004	19:11:33	709.5158	51.298	34.298	26.334	12.334	30.222
12/21/2004	19:13:33	711.5158	51.773	34.773	26.348	12.348	30.222
12/21/2004	19:15:33	713.5158	51.6	34.6	26.348	12.348	30.222
12/21/2004	19:17:33	715.5158	51.168	34.168	26.377	12.377	30.226
12/21/2004	19:19:33	717.5158	51.067	34.067	26.391	12.391	30.226
12/21/2004	19:21:33	719.5158	51.226	34.226	26.405	12.405	30.226
12/21/2004	19:23:33	721.5158	51.989	34.989	26.405	12.405	30.226
12/21/2004	19:25:33	723.5158	51.269	34.269	26.42	12.42	30.228
12/21/2004	19:27:33	725.5158	51.039	34.039	26.42	12.42	30.231
12/21/2004	19:29:33	727.5158	51.687	34.687	26.448	12.448	30.231
12/21/2004	19:31:33	729.5158	51.327	34.327	26.448	12.448	30.231
12/21/2004	19:33:33	731.5158	51.615	34.615	26.477	12.477	30.231
12/21/2004	19:35:33	733.5158	51.6	34.6	26.477	12.477	30.235
12/21/2004	19:37:33	735.5158	51.514	34.514	26.491	12.491	30.233
12/21/2004	19:39:33	737.5158	51.442	34.442	26.506	12.506	30.235
12/21/2004	19:41:33	739.5158	51.456	34.456	26.506	12.506	30.237
12/21/2004	19:43:33	741.5158	51.327	34.327	26.534	12.534	30.237
12/21/2004	19:45:33	743.5158	51.658	34.658	26.534	12.534	30.237
12/21/2004	19:47:33	745.5158	51.139	34.139	26.549	12.549	30.237

12/21/2004	19:49:33	747.5158	51.874	34.874	26.549	12.549	30.239
12/21/2004	19:51:33	749.5158	51.183	34.183	26.563	12.563	30.239
12/21/2004	19:53:33	751.5158	51.543	34.543	26.577	12.577	30.239
12/21/2004	19:55:33	753.5158	51.499	34.499	26.592	12.592	30.239
12/21/2004	19:57:33	755.5158	51.183	34.183	26.606	12.606	30.241
12/21/2004	19:59:33	757.5158	51.312	34.312	26.606	12.606	30.241
12/21/2004	20:01:33	759.5158	51.975	34.975	26.62	12.62	30.241
12/21/2004	20:03:33	761.5158	51.024	34.024	26.635	12.635	30.243
12/21/2004	20:05:33	763.5158	51.816	34.816	26.635	12.635	30.245
12/21/2004	20:07:33	765.5158	51.701	34.701	26.649	12.649	30.245
12/21/2004	20:09:33	767.5158	51.571	34.571	26.663	12.663	30.247
12/21/2004	20:11:33	769.5158	51.514	34.514	26.663	12.663	30.243
12/21/2004	20:13:33	771.5158	51.73	34.73	26.678	12.678	30.247
12/21/2004	20:15:33	773.5158	52.104	35.104	26.692	12.692	30.247
12/21/2004	20:17:33	775.5158	51.744	34.744	26.706	12.706	30.247
12/21/2004	20:19:33	777.5158	51.859	34.859	26.706	12.706	30.249
12/21/2004	20:21:33	779.5158	51.759	34.759	26.721	12.721	30.251
12/21/2004	20:23:33	781.5158	51.903	34.903	26.749	12.749	30.253
12/21/2004	20:25:33	783.5158	51.802	34.802	26.764	12.764	30.251
12/21/2004	20:27:33	785.5158	51.499	34.499	26.764	12.764	30.253
12/21/2004	20:29:33	787.5158	51.658	34.658	26.792	12.792	30.255
12/21/2004	20:31:33	789.5158	51.917	34.917	26.792	12.792	30.253
12/21/2004	20:33:33	791.5158	51.658	34.658	26.807	12.807	30.255
12/21/2004	20:35:33	793.5158	51.615	34.615	26.807	12.807	30.255
12/21/2004	20:37:33	795.5158	52.003	35.003	26.821	12.821	30.253
12/21/2004	20:39:33	797.5158	51.615	34.615	26.835	12.835	30.253
12/21/2004	20:41:33	799.5158	52.032	35.032	26.835	12.835	30.255
12/21/2004	20:43:33	801.5158	51.586	34.586	26.85	12.85	30.255
12/21/2004	20:45:33	803.5158	51.687	34.687	26.85	12.85	30.255
12/21/2004	20:47:33	805.5158	52.104	35.104	26.864	12.864	30.255
12/21/2004	20:49:33	807.5158	52.191	35.191	26.878	12.878	30.257
12/21/2004	20:51:33	809.5158	51.989	34.989	26.878	12.878	30.257
12/21/2004	20:53:33	811.5158	51.471	34.471	26.893	12.893	30.259
12/21/2004	20:55:33	813.5158	51.687	34.687	26.893	12.893	30.261
12/21/2004	20:57:33	815.5158	52.032	35.032	26.907	12.907	30.263
12/21/2004	20:59:33	817.5158	51.701	34.701	26.907	12.907	30.263
12/21/2004	21:01:33	819.5158	52.162	35.162	26.921	12.921	30.263
12/21/2004	21:03:33	821.5158	51.514	34.514	26.921	12.921	30.263
12/21/2004	21:05:33	823.5158	52.133	35.133	26.936	12.936	30.267
12/21/2004	21:07:33	825.5158	51.715	34.715	26.95	12.95	30.267
12/21/2004	21:09:33	827.5158	52.205	35.205	26.95	12.95	30.265
12/21/2004	21:11:33	829.5158	51.888	34.888	26.964	12.964	30.269
12/21/2004	21:13:33	831.5158	52.335	35.335	26.979	12.979	30.265
12/21/2004	21:15:33	833.5158	52.176	35.176	26.979	12.979	30.269
12/21/2004	21:17:33	835.5158	52.133	35.133	26.993	12.993	30.269
12/21/2004	21:19:33	837.5158	52.032	35.032	26.993	12.993	30.269
12/21/2004	21:21:33	839.5158	52.162	35.162	26.993	12.993	30.269
12/21/2004	21:23:33	841.5158	51.931	34.931	27.007	13.007	30.271
12/21/2004	21:25:33	843.5158	51.859	34.859	27.007	13.007	30.273
12/21/2004	21:27:33	845.5158	52.292	35.292	27.022	13.022	30.271
12/21/2004	21:29:33	847.5158	51.845	34.845	27.036	13.036	30.273
12/21/2004	21:31:33	849.5158	52.277	35.277	27.036	13.036	30.275

12/21/2004	21:33:33	851.5158	52.061	35.061	27.05	13.05	30.277
12/21/2004	21:35:33	853.5158	52.378	35.378	27.065	13.065	30.277
12/21/2004	21:37:33	855.5158	51.975	34.975	27.065	13.065	30.277
12/21/2004	21:39:33	857.5158	51.744	34.744	27.065	13.065	30.279
12/21/2004	21:41:33	859.5158	52.234	35.234	27.065	13.065	30.279
12/21/2004	21:43:33	861.5158	52.364	35.364	27.079	13.079	30.279
12/21/2004	21:45:33	863.5158	52.003	35.003	27.093	13.093	30.277
12/21/2004	21:47:33	865.5158	52.075	35.075	27.093	13.093	30.277
12/21/2004	21:49:33	867.5158	52.407	35.407	27.093	13.093	30.279
12/21/2004	21:51:33	869.5158	51.946	34.946	27.093	13.093	30.279
12/21/2004	21:53:33	871.5158	52.335	35.335	27.108	13.108	30.281
12/21/2004	21:55:33	873.5158	52.22	35.22	27.108	13.108	30.281
12/21/2004	21:57:33	875.5158	52.191	35.191	27.136	13.136	30.281
12/21/2004	21:59:33	877.5158	52.378	35.378	27.136	13.136	30.281
12/21/2004	22:01:33	879.5158	52.32	35.32	27.136	13.136	30.286
12/21/2004	22:03:33	881.5158	52.248	35.248	27.136	13.136	30.283
12/21/2004	22:05:33	883.5158	51.874	34.874	27.151	13.151	30.283
12/21/2004	22:07:33	885.5158	52.133	35.133	27.151	13.151	30.286
12/21/2004	22:09:33	887.5158	52.176	35.176	27.151	13.151	30.286
12/21/2004	22:11:33	889.5158	52.335	35.335	27.151	13.151	30.286
12/21/2004	22:13:33	891.5158	51.989	34.989	27.165	13.165	30.286
12/21/2004	22:15:33	893.5158	52.536	35.536	27.165	13.165	30.283
12/21/2004	22:17:33	895.5158	52.508	35.508	27.165	13.165	30.283
12/21/2004	22:19:33	897.5158	52.018	35.018	27.165	13.165	30.283
12/21/2004	22:21:33	899.5158	52.119	35.119	27.165	13.165	30.281
12/21/2004	22:23:33	901.5158	51.874	34.874	27.179	13.179	30.281
12/21/2004	22:25:33	903.5158	52.205	35.205	27.179	13.179	30.281
12/21/2004	22:27:33	905.5158	51.874	34.874	27.179	13.179	30.279
12/21/2004	22:29:33	907.5158	52.162	35.162	27.194	13.194	30.281
12/21/2004	22:31:33	909.5158	52.032	35.032	27.179	13.179	30.283
12/21/2004	22:33:33	911.5158	52.32	35.32	27.179	13.179	30.283
12/21/2004	22:35:33	913.5158	52.378	35.378	27.194	13.194	30.283
12/21/2004	22:37:33	915.5158	51.931	34.931	27.194	13.194	30.283
12/21/2004	22:39:33	917.5158	52.133	35.133	27.194	13.194	30.281
12/21/2004	22:41:33	919.5158	52.191	35.191	27.208	13.208	30.286
12/21/2004	22:43:33	921.5158	52.292	35.292	27.208	13.208	30.286
12/21/2004	22:45:33	923.5158	52.608	35.608	27.208	13.208	30.286
12/21/2004	22:47:33	925.5158	51.903	34.903	27.222	13.222	30.286
12/21/2004	22:49:33	927.5158	52.075	35.075	27.222	13.222	30.286
12/21/2004	22:51:33	929.5158	52.234	35.234	27.237	13.237	30.283
12/21/2004	22:53:33	931.5158	51.917	34.917	27.237	13.237	30.286
12/21/2004	22:55:33	933.5158	52.45	35.45	27.222	13.222	30.286
12/21/2004	22:57:33	935.5158	52.349	35.349	27.237	13.237	30.286
12/21/2004	22:59:33	937.5158	52.421	35.421	27.237	13.237	30.286
12/21/2004	23:01:33	939.5158	52.018	35.018	27.251	13.251	30.288
12/21/2004	23:03:33	941.5158	52.349	35.349	27.237	13.237	30.286
12/21/2004	23:05:33	943.5158	51.917	34.917	27.251	13.251	30.288
12/21/2004	23:07:33	945.5158	51.931	34.931	27.251	13.251	30.288
12/21/2004	23:09:33	947.5158	52.003	35.003	27.251	13.251	30.288
12/21/2004	23:11:33	949.5158	52.292	35.292	27.251	13.251	30.288
12/21/2004	23:13:33	951.5158	52.061	35.061	27.251	13.251	30.292
12/21/2004	23:15:33	953.5158	52.306	35.306	27.237	13.237	30.29

12/21/2004	23:17:33	955.5158	52.392	35.392	27.251	13.251	30.292
12/21/2004	23:19:33	957.5158	52.32	35.32	27.251	13.251	30.288
12/21/2004	23:21:33	959.5158	52.032	35.032	27.251	13.251	30.292
12/21/2004	23:23:33	961.5158	51.787	34.787	27.265	13.265	30.29
12/21/2004	23:25:33	963.5158	52.234	35.234	27.265	13.265	30.292
12/21/2004	23:27:33	965.5158	52.147	35.147	27.265	13.265	30.29
12/21/2004	23:29:33	967.5158	52.234	35.234	27.265	13.265	30.292
12/21/2004	23:31:33	969.5158	51.96	34.96	27.251	13.251	30.294
12/21/2004	23:33:33	971.5158	52.061	35.061	27.251	13.251	30.292
12/21/2004	23:35:33	973.5158	52.421	35.421	27.265	13.265	30.292
12/21/2004	23:37:33	975.5158	52.479	35.479	27.265	13.265	30.294
12/21/2004	23:39:33	977.5158	52.133	35.133	27.28	13.28	30.294
12/21/2004	23:41:33	979.5158	52.263	35.263	27.28	13.28	30.294
12/21/2004	23:43:33	981.5158	52.565	35.565	27.28	13.28	30.294
12/21/2004	23:45:33	983.5158	52.263	35.263	27.265	13.265	30.292
12/21/2004	23:47:33	985.5158	51.931	34.931	27.265	13.265	30.292
12/21/2004	23:49:33	987.5158	52.392	35.392	27.265	13.265	30.294
12/21/2004	23:51:33	989.5158	52.09	35.09	27.265	13.265	30.292
12/21/2004	23:53:33	991.5158	52.58	35.58	27.28	13.28	30.294
12/21/2004	23:55:33	993.5158	52.335	35.335	27.265	13.265	30.292
12/21/2004	23:57:33	995.5158	52.565	35.565	27.265	13.265	30.294
12/21/2004	23:59:33	997.5158	51.946	34.946	27.265	13.265	30.294
12/22/2004	0:01:33	999.5158	52.335	35.335	27.265	13.265	30.294
12/22/2004	0:03:33	1001.516	52.292	35.292	27.265	13.265	30.294
12/22/2004	0:05:33	1003.516	51.73	34.73	27.265	13.265	30.294
12/22/2004	0:07:33	1005.516	52.508	35.508	27.251	13.251	30.294
12/22/2004	0:09:33	1007.516	52.335	35.335	27.265	13.265	30.294
12/22/2004	0:11:33	1009.516	52.421	35.421	27.265	13.265	30.296
12/22/2004	0:13:33	1011.516	52.248	35.248	27.265	13.265	30.294
12/22/2004	0:15:33	1013.516	51.96	34.96	27.251	13.251	30.296
12/22/2004	0:17:33	1015.516	52.565	35.565	27.251	13.251	30.296
12/22/2004	0:19:33	1017.516	52.234	35.234	27.251	13.251	30.298
12/22/2004	0:21:33	1019.516	52.191	35.191	27.251	13.251	30.296
12/22/2004	0:23:33	1021.516	52.075	35.075	27.251	13.251	30.296
12/22/2004	0:25:33	1023.516	52.32	35.32	27.251	13.251	30.296
12/22/2004	0:27:33	1025.516	51.859	34.859	27.251	13.251	30.296
12/22/2004	0:29:33	1027.516	52.436	35.436	27.251	13.251	30.294
12/22/2004	0:31:33	1029.516	52.22	35.22	27.251	13.251	30.298
12/22/2004	0:33:33	1031.516	52.075	35.075	27.251	13.251	30.298
12/22/2004	0:35:33	1033.516	52.58	35.58	27.251	13.251	30.298
12/22/2004	0:37:33	1035.516	52.464	35.464	27.237	13.237	30.296
12/22/2004	0:39:33	1037.516	52.292	35.292	27.237	13.237	30.3
12/22/2004	0:41:33	1039.516	52.032	35.032	27.237	13.237	30.3
12/22/2004	0:43:33	1041.516	52.22	35.22	27.237	13.237	30.3
12/22/2004	0:45:33	1043.516	52.119	35.119	27.237	13.237	30.3
12/22/2004	0:47:33	1045.516	52.436	35.436	27.237	13.237	30.298
12/22/2004	0:49:33	1047.516	51.874	34.874	27.237	13.237	30.302
12/22/2004	0:51:33	1049.516	51.73	34.73	27.237	13.237	30.3
12/22/2004	0:53:33	1051.516	52.392	35.392	27.222	13.222	30.3
12/22/2004	0:55:33	1053.516	52.464	35.464	27.222	13.222	30.298
12/22/2004	0:57:33	1055.516	52.392	35.392	27.222	13.222	30.3
12/22/2004	0:59:33	1057.516	51.787	34.787	27.208	13.208	30.3

12/22/2004	1:01:33	1059.516	52.594	35.594	27.208	13.208	30.3
12/22/2004	1:03:33	1061.516	51.946	34.946	27.208	13.208	30.3
12/22/2004	1:05:33	1063.516	52.407	35.407	27.208	13.208	30.3
12/22/2004	1:07:33	1065.516	52.436	35.436	27.208	13.208	30.3
12/22/2004	1:09:33	1067.516	51.931	34.931	27.194	13.194	30.302
12/22/2004	1:11:33	1069.516	52.061	35.061	27.194	13.194	30.3
12/22/2004	1:13:33	1071.516	52.536	35.536	27.194	13.194	30.3
12/22/2004	1:15:33	1073.516	52.205	35.205	27.194	13.194	30.3
12/22/2004	1:17:33	1075.516	52.22	35.22	27.179	13.179	30.3
12/22/2004	1:19:33	1077.516	52.522	35.522	27.179	13.179	30.3
12/22/2004	1:21:33	1079.516	52.075	35.075	27.179	13.179	30.302
12/22/2004	1:23:33	1081.516	52.407	35.407	27.179	13.179	30.3
12/22/2004	1:25:33	1083.516	52.32	35.32	27.165	13.165	30.3
12/22/2004	1:27:33	1085.516	52.392	35.392	27.165	13.165	30.3
12/22/2004	1:29:33	1087.516	52.58	35.58	27.165	13.165	30.3
12/22/2004	1:31:33	1089.516	52.147	35.147	27.151	13.151	30.302
12/22/2004	1:33:33	1091.516	51.96	34.96	27.151	13.151	30.3
12/22/2004	1:35:33	1093.516	51.946	34.946	27.151	13.151	30.3
12/22/2004	1:37:33	1095.516	52.047	35.047	27.136	13.136	30.3
12/22/2004	1:39:33	1097.516	52.911	35.911	27.136	13.136	30.302
12/22/2004	1:41:33	1099.516	52.133	35.133	27.136	13.136	30.304
12/22/2004	1:43:33	1101.516	52.032	35.032	27.136	13.136	30.304
12/22/2004	1:45:33	1103.516	52.392	35.392	27.136	13.136	30.304
12/22/2004	1:47:33	1105.516	52.133	35.133	27.136	13.136	30.304
12/22/2004	1:49:33	1107.516	51.946	34.946	27.122	13.122	30.304
12/22/2004	1:51:33	1109.516	52.061	35.061	27.122	13.122	30.304
12/22/2004	1:53:33	1111.516	52.335	35.335	27.122	13.122	30.304
12/22/2004	1:55:33	1113.516	52.464	35.464	27.108	13.108	30.304
12/22/2004	1:57:33	1115.516	51.816	34.816	27.122	13.122	30.304
12/22/2004	1:59:33	1117.516	51.975	34.975	27.108	13.108	30.304
12/22/2004	2:01:33	1119.516	52.493	35.493	27.108	13.108	30.306
12/22/2004	2:03:33	1121.516	52.292	35.292	27.093	13.093	30.308
12/22/2004	2:05:33	1123.516	52.464	35.464	27.093	13.093	30.308
12/22/2004	2:07:33	1125.516	52.277	35.277	27.093	13.093	30.31
12/22/2004	2:09:33	1127.516	51.6	34.6	27.093	13.093	30.31
12/22/2004	2:11:33	1129.516	51.802	34.802	27.093	13.093	30.312
12/22/2004	2:13:33	1131.516	51.859	34.859	27.093	13.093	30.312
12/22/2004	2:15:33	1133.516	52.349	35.349	27.079	13.079	30.31
12/22/2004	2:17:33	1135.516	52.09	35.09	27.079	13.079	30.312
12/22/2004	2:19:33	1137.516	52.234	35.234	27.093	13.093	30.312
12/22/2004	2:21:33	1139.516	51.859	34.859	27.079	13.079	30.312
12/22/2004	2:23:33	1141.516	52.133	35.133	27.079	13.079	30.312
12/22/2004	2:25:33	1143.516	51.917	34.917	27.065	13.065	30.314
12/22/2004	2:27:33	1145.516	52.464	35.464	27.065	13.065	30.314
12/22/2004	2:29:33	1147.516	52.075	35.075	27.05	13.05	30.312
12/22/2004	2:31:33	1149.516	51.989	34.989	27.05	13.05	30.312
12/22/2004	2:33:33	1151.516	52.032	35.032	27.05	13.05	30.312
12/22/2004	2:35:33	1153.516	51.499	34.499	27.036	13.036	30.312
12/22/2004	2:37:33	1155.516	52.493	35.493	27.036	13.036	30.31
12/22/2004	2:39:33	1157.516	52.205	35.205	27.036	13.036	30.31
12/22/2004	2:41:33	1159.516	52.378	35.378	27.036	13.036	30.312
12/22/2004	2:43:33	1161.516	51.658	34.658	27.036	13.036	30.312

12/22/2004	2:45:33	1163.516	51.946	34.946	27.036	13.036	30.314
12/22/2004	2:47:33	1165.516	52.162	35.162	27.022	13.022	30.312
12/22/2004	2:49:33	1167.516	52.277	35.277	27.022	13.022	30.312
12/22/2004	2:51:33	1169.516	52.09	35.09	27.022	13.022	30.316
12/22/2004	2:53:33	1171.516	52.32	35.32	27.022	13.022	30.316
12/22/2004	2:55:33	1173.516	52.104	35.104	27.007	13.007	30.314
12/22/2004	2:57:33	1175.516	51.874	34.874	27.007	13.007	30.316
12/22/2004	2:59:33	1177.516	52.191	35.191	27.007	13.007	30.318
12/22/2004	3:01:33	1179.516	52.263	35.263	26.993	12.993	30.314
12/22/2004	3:03:33	1181.516	52.234	35.234	26.979	12.979	30.318
12/22/2004	3:05:33	1183.516	52.58	35.58	26.993	12.993	30.32
12/22/2004	3:07:33	1185.516	52.133	35.133	26.979	12.979	30.318
12/22/2004	3:09:33	1187.516	52.162	35.162	26.979	12.979	30.32
12/22/2004	3:11:33	1189.516	52.205	35.205	26.979	12.979	30.318
12/22/2004	3:13:33	1191.516	52.594	35.594	26.979	12.979	30.318
12/22/2004	3:15:33	1193.516	52.292	35.292	26.964	12.964	30.318
12/22/2004	3:17:33	1195.516	52.464	35.464	26.964	12.964	30.316
12/22/2004	3:19:33	1197.516	52.191	35.191	26.964	12.964	30.316
12/22/2004	3:21:33	1199.516	51.73	34.73	26.964	12.964	30.318
12/22/2004	3:23:33	1201.516	52.637	35.637	26.979	12.979	30.318
12/22/2004	3:25:33	1203.516	52.09	35.09	26.964	12.964	30.322
12/22/2004	3:27:33	1205.516	52.075	35.075	26.964	12.964	30.32
12/22/2004	3:29:33	1207.516	51.845	34.845	26.964	12.964	30.322
12/22/2004	3:31:33	1209.516	51.903	34.903	26.964	12.964	30.322
12/22/2004	3:33:33	1211.516	52.075	35.075	26.964	12.964	30.322
12/22/2004	3:35:33	1213.516	52.047	35.047	26.95	12.95	30.32
12/22/2004	3:37:33	1215.516	51.672	34.672	26.95	12.95	30.322
12/22/2004	3:39:33	1217.516	52.464	35.464	26.95	12.95	30.322
12/22/2004	3:41:33	1219.516	52.003	35.003	26.95	12.95	30.322
12/22/2004	3:43:33	1221.516	52.767	35.767	26.95	12.95	30.322
12/22/2004	3:45:33	1223.516	52.234	35.234	26.936	12.936	30.326
12/22/2004	3:47:33	1225.516	52.364	35.364	26.95	12.95	30.324
12/22/2004	3:49:33	1227.516	52.306	35.306	26.95	12.95	30.326
12/22/2004	3:51:33	1229.516	52.032	35.032	26.95	12.95	30.33
12/22/2004	3:53:33	1231.516	52.032	35.032	26.95	12.95	30.328
12/22/2004	3:55:33	1233.516	52.061	35.061	26.95	12.95	30.328
12/22/2004	3:57:33	1235.516	51.802	34.802	26.964	12.964	30.33
12/22/2004	3:59:33	1237.516	51.888	34.888	26.95	12.95	30.328
12/22/2004	4:01:33	1239.516	52.277	35.277	26.964	12.964	30.328
12/22/2004	4:03:33	1241.516	51.989	34.989	26.964	12.964	30.328
12/22/2004	4:05:33	1243.516	52.061	35.061	26.95	12.95	30.33
12/22/2004	4:07:33	1245.516	52.133	35.133	26.964	12.964	30.332
12/22/2004	4:09:33	1247.516	52.205	35.205	26.95	12.95	30.332
12/22/2004	4:11:33	1249.516	52.234	35.234	26.95	12.95	30.332
12/22/2004	4:13:33	1251.516	52.104	35.104	26.95	12.95	30.334
12/22/2004	4:15:33	1253.516	52.032	35.032	26.95	12.95	30.334
12/22/2004	4:17:33	1255.516	52.047	35.047	26.95	12.95	30.336
12/22/2004	4:19:33	1257.516	52.162	35.162	26.95	12.95	30.336
12/22/2004	4:21:33	1259.516	52.205	35.205	26.964	12.964	30.336
12/22/2004	4:23:33	1261.516	51.975	34.975	26.979	12.979	30.336
12/22/2004	4:25:33	1263.516	52.032	35.032	26.964	12.964	30.336
12/22/2004	4:27:33	1265.516	52.047	35.047	26.964	12.964	30.336



12/22/2004	4:29:33	1267.516	52.061	35.061	26.964	12.964	30.336
12/22/2004	4:31:33	1269.516	52.047	35.047	26.964	12.964	30.338
12/22/2004	4:33:33	1271.516	51.888	34.888	26.979	12.979	30.338
12/22/2004	4:35:33	1273.516	52.133	35.133	26.964	12.964	30.338
12/22/2004	4:37:33	1275.516	52.22	35.22	26.979	12.979	30.338
12/22/2004	4:39:33	1277.516	52.248	35.248	26.979	12.979	30.338
12/22/2004	4:41:33	1279.516	52.248	35.248	26.964	12.964	30.34
12/22/2004	4:43:33	1281.516	52.018	35.018	26.979	12.979	30.34
12/22/2004	4:45:33	1283.516	51.845	34.845	26.979	12.979	30.34
12/22/2004	4:47:33	1285.516	51.802	34.802	26.993	12.993	30.34
12/22/2004	4:49:33	1287.516	52.205	35.205	26.993	12.993	30.343
12/22/2004	4:51:33	1289.516	52.075	35.075	26.993	12.993	30.343
12/22/2004	4:53:33	1291.516	52.248	35.248	26.993	12.993	30.343
12/22/2004	4:55:33	1293.516	51.888	34.888	26.993	12.993	30.345
12/22/2004	4:57:33	1295.516	52.162	35.162	26.993	12.993	30.343
12/22/2004	4:59:33	1297.516	51.989	34.989	27.007	13.007	30.347
12/22/2004	5:01:33	1299.516	52.263	35.263	27.007	13.007	30.347
12/22/2004	5:03:33	1301.516	51.975	34.975	27.007	13.007	30.351
12/22/2004	5:05:33	1303.516	52.003	35.003	27.007	13.007	30.349
12/22/2004	5:07:33	1305.516	52.407	35.407	27.007	13.007	30.351
12/22/2004	5:09:33	1307.516	52.104	35.104	27.022	13.022	30.351
12/22/2004	5:11:33	1309.516	51.672	34.672	27.022	13.022	30.353
12/22/2004	5:13:33	1311.516	52.104	35.104	27.022	13.022	30.351
12/22/2004	5:15:33	1313.516	52.263	35.263	27.036	13.036	30.355
12/22/2004	5:17:33	1315.516	52.09	35.09	27.036	13.036	30.353
12/22/2004	5:19:33	1317.516	52.263	35.263	27.05	13.05	30.355
12/22/2004	5:21:33	1319.516	51.975	34.975	27.05	13.05	30.355
12/22/2004	5:23:33	1321.516	52.479	35.479	27.065	13.065	30.359
12/22/2004	5:25:33	1323.516	51.946	34.946	27.065	13.065	30.357
12/22/2004	5:27:33	1325.516	52.277	35.277	27.065	13.065	30.359
12/22/2004	5:29:33	1327.516	52.464	35.464	27.079	13.079	30.361
12/22/2004	5:31:33	1329.516	52.162	35.162	27.065	13.065	30.361
12/22/2004	5:33:33	1331.516	51.672	34.672	27.079	13.079	30.361
12/22/2004	5:35:33	1333.516	52.637	35.637	27.079	13.079	30.361
12/22/2004	5:37:33	1335.516	51.931	34.931	27.079	13.079	30.363
12/22/2004	5:39:33	1337.516	52.263	35.263	27.079	13.079	30.363
12/22/2004	5:41:33	1339.516	52.436	35.436	27.093	13.093	30.365
12/22/2004	5:43:33	1341.516	52.248	35.248	27.108	13.108	30.365
12/22/2004	5:45:33	1343.516	52.652	35.652	27.108	13.108	30.365
12/22/2004	5:47:33	1345.516	52.277	35.277	27.108	13.108	30.365
12/22/2004	5:49:33	1347.516	52.047	35.047	27.108	13.108	30.365
12/22/2004	5:51:33	1349.516	52.09	35.09	27.108	13.108	30.367
12/22/2004	5:53:33	1351.516	52.277	35.277	27.108	13.108	30.367
12/22/2004	5:55:33	1353.516	52.104	35.104	27.108	13.108	30.367
12/22/2004	5:57:33	1355.516	52.522	35.522	27.108	13.108	30.365
12/22/2004	5:59:33	1357.516	52.594	35.594	27.122	13.122	30.367
12/22/2004	6:01:33	1359.516	51.802	34.802	27.136	13.136	30.369
12/22/2004	6:03:33	1361.516	52.392	35.392	27.136	13.136	30.365
12/22/2004	6:05:33	1363.516	52.666	35.666	27.151	13.151	30.367
12/22/2004	6:07:33	1365.516	52.493	35.493	27.136	13.136	30.367
12/22/2004	6:09:33	1367.516	52.522	35.522	27.151	13.151	30.369
12/22/2004	6:11:33	1369.516	52.234	35.234	27.151	13.151	30.371

12/22/2004	6:13:33	1371.516	51.931	34.931	27.151	13.151	30.371
12/22/2004	6:15:33	1373.516	52.205	35.205	27.165	13.165	30.373
12/22/2004	6:17:33	1375.516	52.45	35.45	27.179	13.179	30.373
12/22/2004	6:19:33	1377.516	52.45	35.45	27.179	13.179	30.373
12/22/2004	6:21:33	1379.516	52.364	35.364	27.179	13.179	30.377
12/22/2004	6:23:33	1381.516	51.975	34.975	27.194	13.194	30.377
12/22/2004	6:25:33	1383.516	52.032	35.032	27.194	13.194	30.377
12/22/2004	6:27:33	1385.516	51.802	34.802	27.194	13.194	30.379
12/22/2004	6:29:33	1387.516	52.925	35.925	27.208	13.208	30.379
12/22/2004	6:31:33	1389.516	51.975	34.975	27.208	13.208	30.381
12/22/2004	6:33:33	1391.516	52.464	35.464	27.222	13.222	30.381
12/22/2004	6:35:33	1393.516	52.133	35.133	27.237	13.237	30.381
12/22/2004	6:37:33	1395.516	51.989	34.989	27.237	13.237	30.383
12/22/2004	6:39:33	1397.516	52.263	35.263	27.237	13.237	30.385
12/22/2004	6:41:33	1399.516	52.594	35.594	27.237	13.237	30.387
12/22/2004	6:43:33	1401.516	51.931	34.931	27.237	13.237	30.385
12/22/2004	6:45:33	1403.516	52.09	35.09	27.251	13.251	30.385
12/22/2004	6:47:33	1405.516	52.464	35.464	27.265	13.265	30.387
12/22/2004	6:49:33	1407.516	51.859	34.859	27.265	13.265	30.387
12/22/2004	6:51:33	1409.516	52.767	35.767	27.28	13.28	30.371
12/22/2004	6:53:33	1411.516	52.349	35.349	27.28	13.28	30.357
12/22/2004	6:55:33	1413.516	51.989	34.989	27.294	13.294	30.357
12/22/2004	6:57:33	1415.516	52.421	35.421	27.294	13.294	30.359
12/22/2004	6:59:33	1417.516	52.205	35.205	27.308	13.308	30.361
12/22/2004	7:01:33	1419.516	52.191	35.191	27.308	13.308	30.363
12/22/2004	7:03:33	1421.516	52.003	35.003	27.308	13.308	30.365
12/22/2004	7:05:33	1423.516	52.868	35.868	27.323	13.323	30.365
12/22/2004	7:07:33	1425.516	52.508	35.508	27.323	13.323	30.367
12/22/2004	7:09:33	1427.516	52.608	35.608	27.337	13.337	30.367
12/22/2004	7:11:33	1429.516	52.608	35.608	27.351	13.351	30.371
12/22/2004	7:13:33	1431.516	52.652	35.652	27.351	13.351	30.371
12/22/2004	7:15:33	1433.516	52.421	35.421	27.366	13.366	30.373
12/22/2004	7:17:33	1435.516	52.94	35.94	27.38	13.38	30.375
12/22/2004	7:19:33	1437.516	52.436	35.436	27.38	13.38	30.377
12/22/2004	7:21:33	1439.516	52.349	35.349	27.394	13.394	30.379
12/22/2004	7:23:33	1441.516	52.364	35.364	27.409	13.409	30.383
12/22/2004	7:25:33	1443.516	52.234	35.234	27.423	13.423	30.387
12/22/2004	7:27:33	1445.516	52.364	35.364	27.423	13.423	30.389
12/22/2004	7:29:33	1447.516	52.436	35.436	27.437	13.437	30.393
12/22/2004	7:31:33	1449.516	52.176	35.176	27.452	13.452	30.395
12/22/2004	7:33:33	1451.516	52.508	35.508	27.452	13.452	30.397
12/22/2004	7:35:33	1453.516	52.781	35.781	27.452	13.452	30.4
12/22/2004	7:37:33	1455.516	52.853	35.853	27.466	13.466	30.402
12/22/2004	7:39:33	1457.516	52.306	35.306	27.48	13.48	30.404
12/22/2004	7:41:33	1459.516	52.522	35.522	27.48	13.48	30.402
12/22/2004	7:43:33	1461.516	52.637	35.637	27.495	13.495	30.406
12/22/2004	7:45:33	1463.516	52.68	35.68	27.509	13.509	30.408
12/22/2004	7:47:33	1465.516	52.421	35.421	27.509	13.509	30.406
12/22/2004	7:49:33	1467.516	52.666	35.666	27.523	13.523	30.41
12/22/2004	7:51:33	1469.516	52.263	35.263	27.523	13.523	30.41
12/22/2004	7:53:33	1471.516	52.623	35.623	27.538	13.538	30.41
12/22/2004	7:55:33	1473.516	52.824	35.824	27.538	13.538	30.408

12/22/2004	7:57:33	1475.516	52.752	35.752	27.552	13.552	30.412
12/22/2004	7:59:33	1477.516	52.119	35.119	27.552	13.552	30.41
12/22/2004	8:01:33	1479.516	53.012	36.012	27.566	13.566	30.408
12/22/2004	8:03:33	1481.516	52.652	35.652	27.566	13.566	30.404
12/22/2004	8:05:33	1483.516	52.436	35.436	27.581	13.581	30.402
12/22/2004	8:07:33	1485.516	52.911	35.911	27.581	13.581	30.397
12/22/2004	8:09:33	1487.516	52.32	35.32	27.595	13.595	30.393
12/22/2004	8:11:33	1489.516	52.608	35.608	27.624	13.624	30.389
12/22/2004	8:13:33	1491.516	52.364	35.364	27.624	13.624	30.383
12/22/2004	8:15:33	1493.516	52.853	35.853	27.638	13.638	30.379
12/22/2004	8:17:33	1495.516	52.882	35.882	27.652	13.652	30.377
12/22/2004	8:19:33	1497.516	52.839	35.839	27.652	13.652	30.373
12/22/2004	8:21:33	1499.516	52.738	35.738	27.652	13.652	30.369
12/22/2004	8:23:33	1501.516	52.147	35.147	27.667	13.667	30.361
12/22/2004	8:25:33	1503.516	53.026	36.026	27.667	13.667	30.357
12/22/2004	8:27:33	1505.516	52.796	35.796	27.681	13.681	30.353
12/22/2004	8:29:33	1507.516	52.81	35.81	27.681	13.681	30.349
12/22/2004	8:31:33	1509.516	52.292	35.292	27.71	13.71	30.347
12/22/2004	8:33:33	1511.516	52.133	35.133	27.695	13.695	30.343
12/22/2004	8:35:33	1513.516	52.637	35.637	27.71	13.71	30.345
12/22/2004	8:37:33	1515.516	52.349	35.349	27.724	13.724	30.34
12/22/2004	8:39:33	1517.516	52.81	35.81	27.738	13.738	30.338
12/22/2004	8:41:33	1519.516	52.882	35.882	27.724	13.724	30.336
12/22/2004	8:43:33	1521.516	52.263	35.263	27.738	13.738	30.334
12/22/2004	8:45:33	1523.516	52.608	35.608	27.753	13.753	30.336
12/22/2004	8:47:33	1525.516	52.32	35.32	27.753	13.753	30.332
12/22/2004	8:49:33	1527.516	52.652	35.652	27.767	13.767	30.332
12/22/2004	8:51:33	1529.516	52.752	35.752	27.767	13.767	30.332
12/22/2004	8:53:33	1531.516	52.781	35.781	27.781	13.781	30.332
12/22/2004	8:55:33	1533.516	52.508	35.508	27.796	13.796	30.33
12/22/2004	8:57:33	1535.516	52.796	35.796	27.796	13.796	30.33
12/22/2004	8:59:33	1537.516	52.853	35.853	27.81	13.81	30.33
12/22/2004	9:01:33	1539.516	52.075	35.075	27.81	13.81	30.332
12/22/2004	9:03:33	1541.516	52.954	35.954	27.824	13.824	30.332
12/22/2004	9:05:33	1543.516	53.314	36.314	27.839	13.839	30.328
12/22/2004	9:07:33	1545.516	52.709	35.709	27.839	13.839	30.33
12/22/2004	9:09:33	1547.516	52.868	35.868	27.839	13.839	30.332
12/22/2004	9:11:33	1549.516	52.752	35.752	27.839	13.839	30.334
12/22/2004	9:13:33	1551.516	52.479	35.479	27.853	13.853	30.334
12/22/2004	9:15:33	1553.516	52.896	35.896	27.867	13.867	30.334
12/22/2004	9:17:33	1555.516	52.724	35.724	27.867	13.867	30.336
12/22/2004	9:19:33	1557.516	53.127	36.127	27.882	13.882	30.334
12/22/2004	9:21:33	1559.516	53.127	36.127	27.882	13.882	30.33
12/22/2004	9:23:33	1561.516	52.853	35.853	27.896	13.896	30.334
12/22/2004	9:25:33	1563.516	52.364	35.364	27.91	13.91	30.332
12/22/2004	9:27:33	1565.516	53.012	36.012	27.91	13.91	30.332
12/22/2004	9:29:33	1567.516	52.277	35.277	27.91	13.91	30.334
12/22/2004	9:31:33	1569.516	52.839	35.839	27.925	13.925	30.334
12/22/2004	9:33:33	1571.516	52.637	35.637	27.925	13.925	30.334
12/22/2004	9:35:33	1573.516	52.752	35.752	27.939	13.939	30.338
12/22/2004	9:37:33	1575.516	52.896	35.896	27.939	13.939	30.338
12/22/2004	9:39:33	1577.516	53.012	36.012	27.953	13.953	30.34

12/22/2004	9:41:33	1579.516	52.968	35.968	27.968	13.968	30.338
12/22/2004	9:43:33	1581.516	52.551	35.551	27.968	13.968	30.34
12/22/2004	9:45:33	1583.516	52.594	35.594	27.968	13.968	30.34
12/22/2004	9:47:33	1585.516	52.32	35.32	27.953	13.953	30.336
12/22/2004	9:49:33	1587.516	52.796	35.796	27.968	13.968	30.338
12/22/2004	9:51:33	1589.516	53.429	36.429	27.968	13.968	30.338
12/22/2004	9:53:33	1591.516	52.623	35.623	27.982	13.982	30.338
12/22/2004	9:55:33	1593.516	53.17	36.17	27.982	13.982	30.34
12/22/2004	9:57:33	1595.516	52.896	35.896	27.996	13.996	30.338
12/22/2004	9:59:33	1597.516	53.012	36.012	27.996	13.996	30.336
12/22/2004	10:01:33	1599.516	52.695	35.695	27.996	13.996	30.336
12/22/2004	10:03:33	1601.516	52.853	35.853	28.025	14.025	30.338
12/22/2004	10:05:33	1603.516	52.781	35.781	27.996	13.996	30.338
12/22/2004	10:07:33	1605.516	52.896	35.896	28.011	14.011	30.338
12/22/2004	10:09:33	1607.516	53.156	36.156	28.011	14.011	30.336
12/22/2004	10:11:33	1609.516	53.242	36.242	28.025	14.025	30.336
12/22/2004	10:13:33	1611.516	52.896	35.896	28.025	14.025	30.334
12/22/2004	10:15:33	1613.516	52.853	35.853	28.039	14.039	30.336
12/22/2004	10:17:33	1615.516	52.997	35.997	28.039	14.039	30.338
12/22/2004	10:19:33	1617.516	52.911	35.911	28.039	14.039	30.338
12/22/2004	10:21:33	1619.516	53.242	36.242	28.039	14.039	30.336
12/22/2004	10:23:33	1621.516	52.925	35.925	28.054	14.054	30.336
12/22/2004	10:25:33	1623.516	52.968	35.968	28.039	14.039	30.334
12/22/2004	10:27:33	1625.516	53.012	36.012	28.054	14.054	30.334
12/22/2004	10:29:33	1627.516	52.839	35.839	28.054	14.054	30.336
12/22/2004	10:31:33	1629.516	53.228	36.228	28.068	14.068	30.334
12/22/2004	10:33:33	1631.516	53.242	36.242	28.068	14.068	30.336
12/22/2004	10:35:33	1633.516	53.472	36.472	28.068	14.068	30.338
12/22/2004	10:37:33	1635.516	52.752	35.752	28.068	14.068	30.336
12/22/2004	10:39:33	1637.516	53.314	36.314	28.082	14.082	30.338
12/22/2004	10:41:33	1639.516	53.069	36.069	28.082	14.082	30.334
12/22/2004	10:43:33	1641.516	53.184	36.184	28.082	14.082	30.338
12/22/2004	10:45:33	1643.516	52.724	35.724	28.097	14.097	30.338
12/22/2004	10:47:33	1645.516	53.343	36.343	28.097	14.097	30.34
12/22/2004	10:49:33	1647.516	52.997	35.997	28.082	14.082	30.338
12/22/2004	10:51:33	1649.516	52.781	35.781	28.082	14.082	30.336
12/22/2004	10:53:33	1651.516	53.242	36.242	28.097	14.097	30.336
12/22/2004	10:55:33	1653.516	52.752	35.752	28.111	14.111	30.336
12/22/2004	10:57:33	1655.516	53.112	36.112	28.111	14.111	30.336
12/22/2004	10:59:33	1657.516	53.141	36.141	28.111	14.111	30.336
12/22/2004	11:01:33	1659.516	52.997	35.997	28.111	14.111	30.336
12/22/2004	11:03:33	1661.516	52.349	35.349	28.111	14.111	30.334
12/22/2004	11:05:33	1663.516	53.084	36.084	28.125	14.125	30.336
12/22/2004	11:07:33	1665.516	53.156	36.156	28.125	14.125	30.332
12/22/2004	11:09:33	1667.516	53.314	36.314	28.125	14.125	30.332
12/22/2004	11:11:33	1669.516	53.012	36.012	28.125	14.125	30.33
12/22/2004	11:13:33	1671.516	52.896	35.896	28.14	14.14	30.328
12/22/2004	11:15:33	1673.516	52.767	35.767	28.125	14.125	30.328
12/22/2004	11:17:33	1675.516	52.868	35.868	28.111	14.111	30.328
12/22/2004	11:19:33	1677.516	53.415	36.415	28.125	14.125	30.328
12/22/2004	11:21:33	1679.516	53.458	36.458	28.14	14.14	30.324
12/22/2004	11:23:33	1681.516	52.623	35.623	28.154	14.154	30.324

12/22/2004	11:25:33	1683.516	52.925	35.925	28.154	14.154	30.324
12/22/2004	11:27:33	1685.516	53.098	36.098	28.154	14.154	30.324
12/22/2004	11:29:33	1687.516	53.328	36.328	28.154	14.154	30.322
12/22/2004	11:31:33	1689.516	52.983	35.983	28.154	14.154	30.322
12/22/2004	11:33:33	1691.516	53.04	36.04	28.168	14.168	30.318
12/22/2004	11:35:33	1693.516	52.522	35.522	28.154	14.154	30.318
12/22/2004	11:37:33	1695.516	53.026	36.026	28.14	14.14	30.318
12/22/2004	11:39:33	1697.516	53.012	36.012	28.154	14.154	30.316
12/22/2004	11:41:33	1699.516	53.055	36.055	28.168	14.168	30.314
12/22/2004	11:43:33	1701.516	52.997	35.997	28.168	14.168	30.306
12/22/2004	11:45:33	1703.516	53.544	36.544	28.183	14.183	30.308
12/22/2004	11:47:33	1705.516	53.17	36.17	28.168	14.168	30.308
12/22/2004	11:49:33	1707.516	53.084	36.084	28.154	14.154	30.304
12/22/2004	11:51:33	1709.516	52.94	35.94	28.168	14.168	30.308
12/22/2004	11:53:33	1711.516	52.767	35.767	28.154	14.154	30.306
12/22/2004	11:55:33	1713.516	52.81	35.81	28.168	14.168	30.308
12/22/2004	11:57:33	1715.516	53.285	36.285	28.154	14.154	30.306
12/22/2004	11:59:33	1717.516	52.997	35.997	28.183	14.183	30.302
12/22/2004	12:01:33	1719.516	53.501	36.501	28.154	14.154	30.304
12/22/2004	12:03:33	1721.516	53.66	36.66	28.154	14.154	30.3
12/22/2004	12:05:33	1723.516	52.997	35.997	28.154	14.154	30.298
12/22/2004	12:07:33	1725.516	52.94	35.94	28.154	14.154	30.298
12/22/2004	12:09:33	1727.516	53.213	36.213	28.168	14.168	30.296
12/22/2004	12:11:33	1729.516	53.055	36.055	28.183	14.183	30.298
12/22/2004	12:13:33	1731.516	52.724	35.724	28.183	14.183	30.3
12/22/2004	12:15:33	1733.516	53.328	36.328	28.183	14.183	30.298
12/22/2004	12:17:33	1735.516	52.882	35.882	28.183	14.183	30.302
12/22/2004	12:19:33	1737.516	52.335	35.335	28.168	14.168	30.304
12/22/2004	12:21:33	1739.516	53.271	36.271	28.183	14.183	30.298
12/22/2004	12:23:33	1741.516	52.954	35.954	28.197	14.197	30.3
12/22/2004	12:25:33	1743.516	52.508	35.508	28.197	14.197	30.298
12/22/2004	12:27:33	1745.516	52.882	35.882	28.183	14.183	30.298
12/22/2004	12:29:33	1747.516	53.084	36.084	28.183	14.183	30.294
12/22/2004	12:31:33	1749.516	53.213	36.213	28.168	14.168	30.294
12/22/2004	12:33:33	1751.516	53.026	36.026	28.183	14.183	30.294
12/22/2004	12:35:33	1753.516	52.954	35.954	28.183	14.183	30.292
12/22/2004	12:37:33	1755.516	53.4	36.4	28.197	14.197	30.292
12/22/2004	12:39:33	1757.516	53.242	36.242	28.211	14.211	30.294
12/22/2004	12:41:33	1759.516	53.213	36.213	28.183	14.183	30.294
12/22/2004	12:43:33	1761.516	53.127	36.127	28.183	14.183	30.294
12/22/2004	12:45:33	1763.516	52.853	35.853	28.183	14.183	30.292
12/22/2004	12:47:33	1765.516	52.94	35.94	28.197	14.197	30.292
12/22/2004	12:49:33	1767.516	52.565	35.565	28.183	14.183	30.29
12/22/2004	12:51:33	1769.516	53.055	36.055	28.168	14.168	30.288
12/22/2004	12:53:33	1771.516	53.055	36.055	28.168	14.168	30.288
12/22/2004	12:55:33	1773.516	52.925	35.925	28.168	14.168	30.296
12/22/2004	12:57:33	1775.516	52.968	35.968	28.168	14.168	30.286
12/22/2004	12:59:33	1777.516	53.199	36.199	28.183	14.183	30.279
12/22/2004	13:01:33	1779.516	52.954	35.954	28.168	14.168	30.269
12/22/2004	13:03:33	1781.516	53.069	36.069	28.154	14.154	30.271
12/22/2004	13:05:33	1783.516	53.141	36.141	28.154	14.154	30.277
12/22/2004	13:07:33	1785.516	52.81	35.81	28.154	14.154	30.281

12/22/2004	13:09:33	1787.516	52.882	35.882	28.168	14.168	30.281
12/22/2004	13:11:33	1789.516	52.623	35.623	28.154	14.154	30.283
12/22/2004	13:13:33	1791.516	53.228	36.228	28.154	14.154	30.281
12/22/2004	13:15:33	1793.516	52.94	35.94	28.154	14.154	30.281
12/22/2004	13:17:33	1795.516	53.069	36.069	28.154	14.154	30.279
12/22/2004	13:19:33	1797.516	53.184	36.184	28.168	14.168	30.281
12/22/2004	13:21:33	1799.516	53.285	36.285	28.154	14.154	30.277
12/22/2004	13:23:33	1801.516	53.271	36.271	28.154	14.154	30.277
12/22/2004	13:25:33	1803.516	53.098	36.098	28.154	14.154	30.277
12/22/2004	13:27:33	1805.516	52.997	35.997	28.154	14.154	30.277
12/22/2004	13:29:33	1807.516	52.925	35.925	28.14	14.14	30.275
12/22/2004	13:31:33	1809.516	52.954	35.954	28.125	14.125	30.277
12/22/2004	13:33:33	1811.516	53.055	36.055	28.125	14.125	30.277
12/22/2004	13:35:33	1813.516	52.94	35.94	28.14	14.14	30.279
12/22/2004	13:37:33	1815.516	52.824	35.824	28.14	14.14	30.277
12/22/2004	13:39:33	1817.516	53.256	36.256	28.125	14.125	30.275
12/22/2004	13:41:33	1819.516	52.724	35.724	28.125	14.125	30.275
12/22/2004	13:43:33	1821.516	53.256	36.256	28.111	14.111	30.277
12/22/2004	13:45:33	1823.516	52.738	35.738	28.111	14.111	30.277
12/22/2004	13:47:33	1825.516	53.199	36.199	28.111	14.111	30.275
12/22/2004	13:49:33	1827.516	53.3	36.3	28.111	14.111	30.277
12/22/2004	13:51:33	1829.516	53.026	36.026	28.097	14.097	30.277
12/22/2004	13:53:33	1831.516	52.925	35.925	28.097	14.097	30.279
12/22/2004	13:55:33	1833.516	53.213	36.213	28.097	14.097	30.279
12/22/2004	13:57:33	1835.516	53.3	36.3	28.097	14.097	30.279
12/22/2004	13:59:33	1837.516	52.925	35.925	28.097	14.097	30.279
12/22/2004	14:01:33	1839.516	52.94	35.94	28.097	14.097	30.281
12/22/2004	14:03:33	1841.516	52.911	35.911	28.082	14.082	30.277
12/22/2004	14:05:33	1843.516	52.882	35.882	28.082	14.082	30.275
12/22/2004	14:07:33	1845.516	52.94	35.94	28.082	14.082	30.277
12/22/2004	14:09:33	1847.516	53.242	36.242	28.068	14.068	30.273
12/22/2004	14:11:33	1849.516	53.184	36.184	28.068	14.068	30.275
12/22/2004	14:13:33	1851.516	52.954	35.954	28.054	14.054	30.275
12/22/2004	14:15:33	1853.516	52.81	35.81	28.054	14.054	30.275
12/22/2004	14:17:33	1855.516	52.623	35.623	28.039	14.039	30.277
12/22/2004	14:19:33	1857.516	52.983	35.983	28.054	14.054	30.275
12/22/2004	14:21:33	1859.516	53.156	36.156	28.054	14.054	30.277
12/22/2004	14:23:33	1861.516	53.012	36.012	28.039	14.039	30.279
12/22/2004	14:25:33	1863.516	52.853	35.853	28.039	14.039	30.277
12/22/2004	14:27:33	1865.516	53.04	36.04	28.039	14.039	30.279
12/22/2004	14:29:33	1867.516	52.594	35.594	28.039	14.039	30.279
12/22/2004	14:31:33	1869.516	53.357	36.357	28.025	14.025	30.277
12/22/2004	14:33:33	1871.516	52.738	35.738	28.011	14.011	30.275
12/22/2004	14:35:33	1873.516	52.767	35.767	28.011	14.011	30.275
12/22/2004	14:37:33	1875.516	52.896	35.896	28.025	14.025	30.273
12/22/2004	14:39:33	1877.516	53.271	36.271	28.011	14.011	30.269
12/22/2004	14:41:33	1879.516	53.199	36.199	28.011	14.011	30.267
12/22/2004	14:43:33	1881.516	52.824	35.824	27.996	13.996	30.267
12/22/2004	14:45:33	1883.516	53.141	36.141	27.996	13.996	30.265
12/22/2004	14:47:33	1885.516	52.925	35.925	27.982	13.982	30.267
12/22/2004	14:49:33	1887.516	53.112	36.112	27.982	13.982	30.263
12/22/2004	14:51:33	1889.516	52.868	35.868	27.996	13.996	30.269

12/22/2004	14:53:33	1891.516	52.824	35.824	27.982	13.982	30.269
12/22/2004	14:55:33	1893.516	52.565	35.565	27.982	13.982	30.269
12/22/2004	14:57:33	1895.516	52.436	35.436	27.982	13.982	30.267
12/22/2004	14:59:33	1897.516	53.314	36.314	27.968	13.968	30.267
12/22/2004	15:01:33	1899.516	53.17	36.17	27.968	13.968	30.265
12/22/2004	15:03:33	1901.516	52.551	35.551	27.968	13.968	30.265
12/22/2004	15:05:33	1903.516	53.141	36.141	27.953	13.953	30.263
12/22/2004	15:07:33	1905.516	52.824	35.824	27.968	13.968	30.263
12/22/2004	15:09:33	1907.516	52.364	35.364	27.968	13.968	30.263
12/22/2004	15:11:33	1909.516	52.738	35.738	27.968	13.968	30.263
12/22/2004	15:13:33	1911.516	53.127	36.127	27.953	13.953	30.265
12/22/2004	15:15:33	1913.516	52.954	35.954	27.953	13.953	30.263
12/22/2004	15:17:33	1915.516	52.493	35.493	27.939	13.939	30.263
12/22/2004	15:19:33	1917.516	52.94	35.94	27.925	13.925	30.261
12/22/2004	15:21:33	1919.516	52.954	35.954	27.939	13.939	30.261
12/22/2004	15:23:33	1921.516	52.853	35.853	27.925	13.925	30.261
12/22/2004	15:25:33	1923.516	52.752	35.752	27.925	13.925	30.265
12/22/2004	15:27:33	1925.516	52.896	35.896	27.925	13.925	30.261
12/22/2004	15:29:33	1927.516	52.968	35.968	27.925	13.925	30.261
12/22/2004	15:31:33	1929.516	52.767	35.767	27.925	13.925	30.261
12/22/2004	15:33:33	1931.516	52.781	35.781	27.925	13.925	30.259
12/22/2004	15:35:33	1933.516	52.623	35.623	27.925	13.925	30.259
12/22/2004	15:37:33	1935.516	52.508	35.508	27.91	13.91	30.255
12/22/2004	15:39:33	1937.516	53.156	36.156	27.91	13.91	30.253
12/22/2004	15:41:33	1939.516	53.04	36.04	27.925	13.925	30.251
12/22/2004	15:43:33	1941.516	53.156	36.156	27.925	13.925	30.253
12/22/2004	15:45:33	1943.516	52.983	35.983	27.925	13.925	30.253
12/22/2004	15:47:33	1945.516	53.026	36.026	27.925	13.925	30.253
12/22/2004	15:49:33	1947.516	52.81	35.81	27.91	13.91	30.255
12/22/2004	15:51:33	1949.516	52.666	35.666	27.925	13.925	30.257
12/22/2004	15:53:33	1951.516	52.839	35.839	27.91	13.91	30.263
12/22/2004	15:55:33	1953.516	52.896	35.896	27.925	13.925	30.263
12/22/2004	15:57:33	1955.516	52.882	35.882	27.91	13.91	30.261
12/22/2004	15:59:33	1957.516	53.04	36.04	27.925	13.925	30.259
12/22/2004	16:01:33	1959.516	52.781	35.781	27.91	13.91	30.257
12/22/2004	16:03:33	1961.516	52.968	35.968	27.91	13.91	30.257
12/22/2004	16:05:33	1963.516	53.199	36.199	27.91	13.91	30.251
12/22/2004	16:07:33	1965.516	52.853	35.853	27.91	13.91	30.245
12/22/2004	16:09:33	1967.516	52.565	35.565	27.91	13.91	30.245
12/22/2004	16:11:33	1969.516	52.94	35.94	27.925	13.925	30.239
12/22/2004	16:13:33	1971.516	52.997	35.997	27.925	13.925	30.233
12/22/2004	16:15:33	1973.516	52.493	35.493	27.91	13.91	30.235
12/22/2004	16:17:33	1975.516	53.112	36.112	27.91	13.91	30.233
12/22/2004	16:19:33	1977.516	52.752	35.752	27.925	13.925	30.237
12/22/2004	16:21:33	1979.516	52.796	35.796	27.91	13.91	30.237
12/22/2004	16:23:33	1981.516	53.04	36.04	27.91	13.91	30.243
12/22/2004	16:25:33	1983.516	53.026	36.026	27.91	13.91	30.241
12/22/2004	16:27:33	1985.516	52.364	35.364	27.91	13.91	30.241
12/22/2004	16:29:33	1987.516	52.594	35.594	27.91	13.91	30.241
12/22/2004	16:31:33	1989.516	53.084	36.084	27.91	13.91	30.237
12/22/2004	16:33:33	1991.516	52.896	35.896	27.91	13.91	30.241
12/22/2004	16:35:33	1993.516	52.58	35.58	27.91	13.91	30.241

12/22/2004	16:37:33	1995.516	52.724	35.724	27.896	13.896	30.245
12/22/2004	16:39:33	1997.516	52.983	35.983	27.91	13.91	30.247
12/22/2004	16:41:33	1999.516	52.925	35.925	27.896	13.896	30.245
12/22/2004	16:43:33	2001.516	52.94	35.94	27.91	13.91	30.247
12/22/2004	16:45:33	2003.516	53.588	36.588	27.896	13.896	30.249
12/22/2004	16:47:33	2005.516	53.156	36.156	27.91	13.91	30.253
12/22/2004	16:49:33	2007.516	52.882	35.882	27.925	13.925	30.255
12/22/2004	16:51:33	2009.516	52.853	35.853	27.925	13.925	30.249
12/22/2004	16:53:33	2011.516	52.709	35.709	27.925	13.925	30.249
12/22/2004	16:55:33	2013.516	53.156	36.156	27.925	13.925	30.247
12/22/2004	16:57:33	2015.516	52.551	35.551	27.925	13.925	30.245
12/22/2004	16:59:33	2017.516	52.565	35.565	27.925	13.925	30.247
12/22/2004	17:01:33	2019.516	52.925	35.925	27.939	13.939	30.245
12/22/2004	17:03:33	2021.516	52.839	35.839	27.939	13.939	30.245
12/22/2004	17:05:33	2023.516	52.911	35.911	27.925	13.925	30.245
12/22/2004	17:07:33	2025.516	53.328	36.328	27.939	13.939	30.247
12/22/2004	17:09:33	2027.516	52.853	35.853	27.939	13.939	30.249
12/22/2004	17:11:33	2029.516	52.94	35.94	27.939	13.939	30.249
12/22/2004	17:13:33	2031.516	52.868	35.868	27.925	13.925	30.247
12/22/2004	17:15:33	2033.516	53.156	36.156	27.925	13.925	30.245
12/22/2004	17:17:33	2035.516	52.637	35.637	27.939	13.939	30.251
12/22/2004	17:19:33	2037.516	52.464	35.464	27.939	13.939	30.249
12/22/2004	17:21:33	2039.516	52.94	35.94	27.939	13.939	30.251
12/22/2004	17:23:33	2041.516	52.68	35.68	27.939	13.939	30.251
12/22/2004	17:25:33	2043.516	53.084	36.084	27.939	13.939	30.249
12/22/2004	17:27:33	2045.516	53.012	36.012	27.953	13.953	30.249
12/22/2004	17:29:33	2047.516	52.479	35.479	27.968	13.968	30.247
12/22/2004	17:31:33	2049.516	52.954	35.954	27.968	13.968	30.249
12/22/2004	17:33:33	2051.516	52.882	35.882	27.968	13.968	30.249
12/22/2004	17:35:33	2053.516	52.536	35.536	27.953	13.953	30.249
12/22/2004	17:37:33	2055.516	52.853	35.853	27.968	13.968	30.249
12/22/2004	17:39:33	2057.516	52.781	35.781	27.982	13.982	30.249
12/22/2004	17:41:33	2059.516	53.199	36.199	27.982	13.982	30.251
12/22/2004	17:43:33	2061.516	52.997	35.997	27.982	13.982	30.253
12/22/2004	17:45:33	2063.516	53.127	36.127	27.982	13.982	30.253
12/22/2004	17:47:33	2065.516	53.199	36.199	27.982	13.982	30.251
12/22/2004	17:49:33	2067.516	53.055	36.055	27.982	13.982	30.249
12/22/2004	17:51:33	2069.516	53.04	36.04	27.982	13.982	30.243
12/22/2004	17:53:33	2071.516	53.573	36.573	27.982	13.982	30.243
12/22/2004	17:55:33	2073.516	53.429	36.429	27.996	13.996	30.243
12/22/2004	17:57:33	2075.516	52.508	35.508	27.982	13.982	30.241
12/22/2004	17:59:33	2077.516	52.94	35.94	27.982	13.982	30.241
12/22/2004	18:01:33	2079.516	52.45	35.45	27.996	13.996	30.245
12/22/2004	18:03:33	2081.516	53.415	36.415	27.996	13.996	30.245
12/22/2004	18:05:33	2083.516	52.94	35.94	27.996	13.996	30.245
12/22/2004	18:07:33	2085.516	53.285	36.285	27.996	13.996	30.243
12/22/2004	18:09:33	2087.516	53.746	36.746	27.996	13.996	30.243
12/22/2004	18:11:33	2089.516	52.781	35.781	28.025	14.025	30.245
12/22/2004	18:13:33	2091.516	52.824	35.824	28.039	14.039	30.243
12/22/2004	18:15:33	2093.516	53.386	36.386	28.039	14.039	30.241
12/22/2004	18:17:33	2095.516	53.343	36.343	28.039	14.039	30.243
12/22/2004	18:19:33	2097.516	53.429	36.429	28.039	14.039	30.243



12/22/2004	18:21:33	2099.516	53.271	36.271	28.054	14.054	30.239
12/22/2004	18:23:33	2101.516	53.429	36.429	28.054	14.054	30.243
12/22/2004	18:25:33	2103.516	53.012	36.012	28.054	14.054	30.243
12/22/2004	18:27:33	2105.516	52.94	35.94	28.068	14.068	30.243
12/22/2004	18:29:33	2107.516	53.127	36.127	28.068	14.068	30.243
12/22/2004	18:31:33	2109.516	52.911	35.911	28.068	14.068	30.241
12/22/2004	18:33:33	2111.516	53.372	36.372	28.068	14.068	30.243
12/22/2004	18:35:33	2113.516	52.839	35.839	28.068	14.068	30.243
12/22/2004	18:37:33	2115.516	53.4	36.4	28.082	14.082	30.241
12/22/2004	18:39:33	2117.516	52.695	35.695	28.082	14.082	30.243
12/22/2004	18:41:33	2119.516	53.256	36.256	28.082	14.082	30.245
12/22/2004	18:43:33	2121.516	52.752	35.752	28.082	14.082	30.243
12/22/2004	18:45:33	2123.516	53.184	36.184	28.097	14.097	30.245
12/22/2004	18:47:33	2125.516	53.127	36.127	28.097	14.097	30.245
12/22/2004	18:49:33	2127.516	53.04	36.04	28.111	14.111	30.245
12/22/2004	18:51:33	2129.516	53.184	36.184	28.125	14.125	30.247
12/22/2004	18:53:33	2131.516	53.055	36.055	28.125	14.125	30.245
12/22/2004	18:55:33	2133.516	53.012	36.012	28.125	14.125	30.249
12/22/2004	18:57:33	2135.516	53.271	36.271	28.125	14.125	30.249
12/22/2004	18:59:33	2137.516	52.839	35.839	28.14	14.14	30.247
12/22/2004	19:01:33	2139.516	52.983	35.983	28.14	14.14	30.247
12/22/2004	19:03:33	2141.516	53.213	36.213	28.14	14.14	30.247
12/22/2004	19:05:33	2143.516	52.565	35.565	28.14	14.14	30.243
12/22/2004	19:07:33	2145.516	53.386	36.386	28.154	14.154	30.247
12/22/2004	19:09:33	2147.516	53.271	36.271	28.154	14.154	30.245
12/22/2004	19:11:33	2149.516	53.127	36.127	28.14	14.14	30.245
12/22/2004	19:13:33	2151.516	53.271	36.271	28.154	14.154	30.247
12/22/2004	19:15:33	2153.516	53.256	36.256	28.154	14.154	30.245
12/22/2004	19:17:33	2155.516	53.141	36.141	28.168	14.168	30.243
12/22/2004	19:19:33	2157.516	52.81	35.81	28.168	14.168	30.241
12/22/2004	19:21:33	2159.516	53.242	36.242	28.168	14.168	30.241
12/22/2004	19:23:33	2161.516	53.256	36.256	28.183	14.183	30.239
12/22/2004	19:25:33	2163.516	53.026	36.026	28.211	14.211	30.237
12/22/2004	19:27:33	2165.516	53.17	36.17	28.211	14.211	30.237
12/22/2004	19:29:33	2167.516	53.3	36.3	28.226	14.226	30.237
12/22/2004	19:31:33	2169.516	53.184	36.184	28.226	14.226	30.235
12/22/2004	19:33:33	2171.516	53.746	36.746	28.226	14.226	30.231
12/22/2004	19:35:33	2173.516	53.544	36.544	28.226	14.226	30.231
12/22/2004	19:37:33	2175.516	52.868	35.868	28.24	14.24	30.233
12/22/2004	19:39:33	2177.516	53.487	36.487	28.24	14.24	30.235
12/22/2004	19:41:33	2179.516	53.156	36.156	28.254	14.254	30.235
12/22/2004	19:43:33	2181.516	53.847	36.847	28.254	14.254	30.233
12/22/2004	19:45:33	2183.516	53.444	36.444	28.269	14.269	30.235
12/22/2004	19:47:33	2185.516	53.472	36.472	28.283	14.283	30.233
12/22/2004	19:49:33	2187.516	53.703	36.703	28.269	14.269	30.235
12/22/2004	19:51:33	2189.516	53.458	36.458	28.283	14.283	30.233
12/22/2004	19:53:33	2191.516	53.602	36.602	28.297	14.297	30.233
12/22/2004	19:55:33	2193.516	53.573	36.573	28.297	14.297	30.233
12/22/2004	19:57:33	2195.516	52.925	35.925	28.312	14.312	30.233
12/22/2004	19:59:33	2197.516	53.76	36.76	28.312	14.312	30.233
12/22/2004	20:01:33	2199.516	53.357	36.357	28.326	14.326	30.231
12/22/2004	20:03:33	2201.516	53.501	36.501	28.34	14.34	30.233

12/22/2004	20:05:33	2203.516	53.703	36.703	28.34	14.34	30.231
12/22/2004	20:07:33	2205.516	53.429	36.429	28.355	14.355	30.228
12/22/2004	20:09:33	2207.516	53.314	36.314	28.355	14.355	30.228
12/22/2004	20:11:33	2209.516	53.199	36.199	28.369	14.369	30.231
12/22/2004	20:13:33	2211.516	53.66	36.66	28.369	14.369	30.233
12/22/2004	20:15:33	2213.516	53.228	36.228	28.369	14.369	30.233
12/22/2004	20:17:33	2215.516	53.228	36.228	28.369	14.369	30.228
12/22/2004	20:19:33	2217.516	53.818	36.818	28.369	14.369	30.226
12/22/2004	20:21:33	2219.516	53.055	36.055	28.383	14.383	30.228
12/22/2004	20:23:33	2221.516	53.53	36.53	28.397	14.397	30.222
12/22/2004	20:25:33	2223.516	53.213	36.213	28.383	14.383	30.22
12/22/2004	20:27:33	2225.516	53.3	36.3	28.383	14.383	30.222
12/22/2004	20:29:33	2227.516	53.372	36.372	28.397	14.397	30.22
12/22/2004	20:31:33	2229.516	53.386	36.386	28.397	14.397	30.218
12/22/2004	20:33:33	2231.516	53.184	36.184	28.412	14.412	30.218
12/22/2004	20:35:33	2233.516	53.069	36.069	28.412	14.412	30.216
12/22/2004	20:37:33	2235.516	53.775	36.775	28.426	14.426	30.216

In-Situ Inc. Hermit 3000

Report general 1/11/2005 9:29:03  
Report from file C:\Win-Situ\Data\SN45813 2004-12-22 203834 DARE REC .bin  
DataMgr Version 3.68

Serial number: 45813  
Firmware Vers 7.1  
Unit name: HERMIT 3000

Test name: DARE REC

Test defined on 12/17/2004 14:26:00  
Test started on 12/22/2004 20:38:34  
Test stopped on 12/24/2004 7:36:54  
Test extracted 1/7/2005 13:53:12

Data gathered using Logarithmic testing

Maximum time Minutes.

Number of data 1136

TOTAL DATA: 1136

Channel number [7]

Measurement Pressure

Channel name #7

Linearity: 0.2503

Scale: 99.8402

Offset: -0.1892

Warmup: 50

Specific gravity 1

Mode: TOC

User-defined 17 Feet H2O

Referenced to channel definition.

Pressure head 58.366 Feet H2O

Channel number [8]

Measurement Pressure

Channel name #8

Linearity: 0.2257

Scale: 99.3761

Offset: -0.1631

Warmup: 50

Specific gravity 1

Mode: TOC

User-defined 14 Feet H2O

Referenced to channel definition.

Pressure head 30.127 Feet H2O

Channel number [0]

Measurement Barometric Pressure

Channel name Barometric

Linearity: 0  
 Scale: 0  
 Offset: 0  
 Warmup: 50

Date	Time	Time (min)	#15		TW #15		-----
			Recovery (feet)	Actual Recovery	Recovery (feet)	Actual Recovery	
12/22/2004	20:38:34	0	52.925	35.925	28.44	14.44	30.251
12/22/2004	20:38:34	0.0163	53.4	36.4	28.44	14.44	30.249
12/22/2004	20:38:35	0.0327	53.588	36.588	28.44	14.44	30.251
12/22/2004	20:38:36	0.049	53.746	36.746	28.44	14.44	30.251
12/22/2004	20:38:37	0.0653	53.444	36.444	28.44	14.44	30.251
12/22/2004	20:38:38	0.0817	53.804	36.804	28.44	14.44	30.251
12/22/2004	20:38:39	0.098	52.954	35.954	28.455	14.455	30.249
12/22/2004	20:38:40	0.1143	53.242	36.242	28.44	14.44	30.251
12/22/2004	20:38:41	0.1307	52.983	35.983	28.44	14.44	30.251
12/22/2004	20:38:42	0.147	50.866	33.866	28.44	14.44	30.251
12/22/2004	20:38:43	0.1633	49.051	32.051	28.44	14.44	30.251
12/22/2004	20:38:44	0.1797	48	31	28.44	14.44	30.251
12/22/2004	20:38:45	0.196	45.667	28.667	28.44	14.44	30.251
12/22/2004	20:38:46	0.2123	43.376	26.376	28.44	14.44	30.251
12/22/2004	20:38:47	0.2287	41.547	24.547	28.44	14.44	30.251
12/22/2004	20:38:48	0.245	39.891	22.891	28.44	14.44	30.249
12/22/2004	20:38:49	0.2613	38.493	21.493	28.44	14.44	30.251
12/22/2004	20:38:50	0.2777	37.384	20.384	28.44	14.44	30.251
12/22/2004	20:38:51	0.294	36.433	19.433	28.426	14.426	30.251
12/22/2004	20:38:52	0.3103	35.929	18.929	28.426	14.426	30.251
12/22/2004	20:38:53	0.3267	35.598	18.598	28.412	14.412	30.249
12/22/2004	20:38:54	0.3433	35.396	18.396	28.397	14.397	30.251
12/22/2004	20:38:55	0.361	35.338	18.338	28.397	14.397	30.251
12/22/2004	20:38:56	0.3797	35.295	18.295	28.383	14.383	30.251
12/22/2004	20:38:57	0.3995	35.18	18.18	28.369	14.369	30.249
12/22/2004	20:38:59	0.4205	34.993	17.993	28.355	14.355	30.251
12/22/2004	20:39:00	0.4427	34.676	17.676	28.312	14.312	30.251
12/22/2004	20:39:01	0.4662	34.301	17.301	28.297	14.297	30.249
12/22/2004	20:39:03	0.491	33.97	16.97	28.269	14.269	30.249
12/22/2004	20:39:05	0.5173	33.768	16.768	28.226	14.226	30.249
12/22/2004	20:39:06	0.5453	33.638	16.638	28.183	14.183	30.249
12/22/2004	20:39:08	0.575	33.523	16.523	28.14	14.14	30.249
12/22/2004	20:39:10	0.6063	33.466	16.466	28.111	14.111	30.249
12/22/2004	20:39:12	0.6395	33.048	16.048	28.039	14.039	30.249
12/22/2004	20:39:14	0.6747	32.774	15.774	27.982	13.982	30.251
12/22/2004	20:39:16	0.712	32.601	15.601	27.925	13.925	30.249
12/22/2004	20:39:19	0.7515	32.529	15.529	27.867	13.867	30.251
12/22/2004	20:39:21	0.7933	32.399	15.399	27.81	13.81	30.249
12/22/2004	20:39:24	0.8377	32.14	15.14	27.738	13.738	30.249
12/22/2004	20:39:27	0.8847	31.967	14.967	27.681	13.681	30.249
12/22/2004	20:39:30	0.9345	31.881	14.881	27.609	13.609	30.247
12/22/2004	20:39:33	0.9872	31.722	14.722	27.552	13.552	30.249
12/22/2004	20:39:36	1.043	31.535	14.535	27.48	13.48	30.247
12/22/2004	20:39:40	1.1022	31.42	14.42	27.409	13.409	30.249

12/22/2004	20:39:43	1.1648	31.29	14.29	27.323	13.323	30.247
12/22/2004	20:39:47	1.2312	31.146	14.146	27.251	13.251	30.247
12/22/2004	20:39:52	1.3015	31.06	14.06	27.194	13.194	30.249
12/22/2004	20:39:56	1.376	30.915	13.915	27.122	13.122	30.249
12/22/2004	20:40:01	1.455	30.8	13.8	27.036	13.036	30.245
12/22/2004	20:40:06	1.5387	30.685	13.685	26.979	12.979	30.249
12/22/2004	20:40:11	1.6272	30.555	13.555	26.893	12.893	30.245
12/22/2004	20:40:17	1.721	30.44	13.44	26.807	12.807	30.247
12/22/2004	20:40:23	1.8203	30.339	13.339	26.735	12.735	30.247
12/22/2004	20:40:29	1.9257	30.238	13.238	26.663	12.663	30.245
12/22/2004	20:40:36	2.0372	30.123	13.123	26.592	12.592	30.245
12/22/2004	20:40:43	2.1553	30.022	13.022	26.506	12.506	30.247
12/22/2004	20:40:50	2.2805	29.907	12.907	26.42	12.42	30.245
12/22/2004	20:40:58	2.413	29.792	12.792	26.348	12.348	30.245
12/22/2004	20:41:07	2.5535	29.691	12.691	26.262	12.262	30.243
12/22/2004	20:41:16	2.7023	29.59	12.59	26.19	12.19	30.243
12/22/2004	20:41:25	2.8598	29.518	12.518	26.104	12.104	30.245
12/22/2004	20:41:35	3.0267	29.431	12.431	26.018	12.018	30.243
12/22/2004	20:41:46	3.2035	29.302	12.302	25.947	11.947	30.243
12/22/2004	20:41:57	3.3908	29.23	12.23	25.875	11.875	30.241
12/22/2004	20:42:09	3.5892	29.071	12.071	25.775	11.775	30.247
12/22/2004	20:42:21	3.7993	28.927	11.927	25.689	11.689	30.216
12/22/2004	20:42:35	4.022	28.869	11.869	25.617	11.617	30.218
12/22/2004	20:42:49	4.2578	28.769	11.769	25.545	11.545	30.218
12/22/2004	20:43:04	4.5077	28.697	11.697	25.459	11.459	30.216
12/22/2004	20:43:20	4.7723	28.596	11.596	25.388	11.388	30.216
12/22/2004	20:43:37	5.0527	28.495	11.495	25.302	11.302	30.214
12/22/2004	20:43:54	5.3495	28.408	11.408	25.216	11.216	30.216
12/22/2004	20:44:13	5.664	28.308	11.308	25.13	11.13	30.218
12/22/2004	20:44:33	5.9972	28.221	11.221	25.058	11.058	30.214
12/22/2004	20:44:55	6.35	28.12	11.12	24.972	10.972	30.216
12/22/2004	20:45:17	6.7238	28.034	11.034	24.886	10.886	30.214
12/22/2004	20:45:41	7.1198	27.947	10.947	24.815	10.815	30.214
12/22/2004	20:46:06	7.5392	27.846	10.846	24.729	10.729	30.216
12/22/2004	20:46:33	7.9835	27.76	10.76	24.657	10.657	30.214
12/22/2004	20:47:01	8.4542	27.659	10.659	24.571	10.571	30.214
12/22/2004	20:47:31	8.9527	27.573	10.573	24.471	10.471	30.216
12/22/2004	20:48:02	9.4807	27.472	10.472	24.385	10.385	30.214
12/22/2004	20:48:36	10.04	27.385	10.385	24.313	10.313	30.216
12/22/2004	20:49:11	10.6325	27.299	10.299	24.227	10.227	30.216
12/22/2004	20:49:49	11.26	27.198	10.198	24.155	10.155	30.216
12/22/2004	20:50:29	11.9248	27.112	10.112	24.069	10.069	30.216
12/22/2004	20:51:11	12.629	27.025	10.025	23.969	9.969	30.216
12/22/2004	20:51:56	13.3748	26.924	9.924	23.897	9.897	30.218
12/22/2004	20:52:43	14.1648	26.823	9.823	23.811	9.811	30.218
12/22/2004	20:53:34	15.0017	26.737	9.737	23.725	9.725	30.216
12/22/2004	20:54:27	15.8882	26.651	9.651	23.639	9.639	30.218
12/22/2004	20:55:23	16.8272	26.55	9.55	23.539	9.539	30.218
12/22/2004	20:56:23	17.8218	26.478	9.478	23.453	9.453	30.216
12/22/2004	20:57:26	18.8755	26.362	9.362	23.367	9.367	30.216
12/22/2004	20:58:33	19.9915	26.276	9.276	23.295	9.295	30.214
12/22/2004	20:59:44	21.1737	26.189	9.189	23.209	9.209	30.214

12/22/2004	21:00:59	22.4258	26.103	9.103	23.109	9.109	30.212
12/22/2004	21:02:19	23.7523	26.017	9.017	23.037	9.037	30.214
12/22/2004	21:03:43	25.1573	25.901	8.901	22.951	8.951	30.214
12/22/2004	21:05:12	26.6457	25.815	8.815	22.851	8.851	30.212
12/22/2004	21:06:47	28.2222	25.728	8.728	22.765	8.765	30.21
12/22/2004	21:08:27	29.892	25.642	8.642	22.665	8.665	30.208
12/22/2004	21:10:13	31.6608	25.555	8.555	22.593	8.593	30.206
12/22/2004	21:12:06	33.5345	25.426	8.426	22.507	8.507	30.208
12/22/2004	21:14:05	35.5192	25.368	8.368	22.421	8.421	30.208
12/22/2004	21:16:05	37.5192	25.282	8.282	22.335	8.335	30.206
12/22/2004	21:18:05	39.5192	25.195	8.195	22.249	8.249	30.206
12/22/2004	21:20:05	41.5192	25.123	8.123	22.177	8.177	30.204
12/22/2004	21:22:05	43.5192	25.066	8.066	22.106	8.106	30.204
12/22/2004	21:24:05	45.5192	24.965	7.965	22.034	8.034	30.202
12/22/2004	21:26:05	47.5192	24.907	7.907	21.977	7.977	30.2
12/22/2004	21:28:05	49.5192	24.849	7.849	21.919	7.919	30.198
12/22/2004	21:30:05	51.5192	24.777	7.777	21.862	7.862	30.196
12/22/2004	21:32:05	53.5192	24.72	7.72	21.79	7.79	30.198
12/22/2004	21:34:05	55.5192	24.662	7.662	21.733	7.733	30.196
12/22/2004	21:36:05	57.5192	24.604	7.604	21.676	7.676	30.196
12/22/2004	21:38:05	59.5192	24.547	7.547	21.618	7.618	30.196
12/22/2004	21:40:05	61.5192	24.504	7.504	21.575	7.575	30.196
12/22/2004	21:42:05	63.5192	24.446	7.446	21.518	7.518	30.194
12/22/2004	21:44:05	65.5192	24.403	7.403	21.475	7.475	30.194
12/22/2004	21:46:05	67.5192	24.359	7.359	21.432	7.432	30.196
12/22/2004	21:48:05	69.5192	24.302	7.302	21.375	7.375	30.194
12/22/2004	21:50:05	71.5192	24.259	7.259	21.332	7.332	30.196
12/22/2004	21:52:05	73.5192	24.215	7.215	21.289	7.289	30.196
12/22/2004	21:54:05	75.5192	24.187	7.187	21.26	7.26	30.194
12/22/2004	21:56:05	77.5192	24.129	7.129	21.217	7.217	30.194
12/22/2004	21:58:05	79.5192	24.086	7.086	21.174	7.174	30.196
12/22/2004	22:00:05	81.5192	24.057	7.057	21.145	7.145	30.194
12/22/2004	22:02:05	83.5192	24.014	7.014	21.102	7.102	30.198
12/22/2004	22:04:05	85.5192	23.985	6.985	21.074	7.074	30.194
12/22/2004	22:06:05	87.5192	23.942	6.942	21.045	7.045	30.194
12/22/2004	22:08:05	89.5192	23.913	6.913	20.988	6.988	30.194
12/22/2004	22:10:05	91.5192	23.884	6.884	20.959	6.959	30.196
12/22/2004	22:12:05	93.5192	23.855	6.855	20.93	6.93	30.196
12/22/2004	22:14:05	95.5192	23.812	6.812	20.916	6.916	30.196
12/22/2004	22:16:05	97.5192	23.783	6.783	20.873	6.873	30.19
12/22/2004	22:18:05	99.5192	23.74	6.74	20.83	6.83	30.188
12/22/2004	22:20:05	101.5192	23.711	6.711	20.801	6.801	30.182
12/22/2004	22:22:05	103.5192	23.682	6.682	20.773	6.773	30.178
12/22/2004	22:24:05	105.5192	23.625	6.625	20.744	6.744	30.174
12/22/2004	22:26:05	107.5192	23.596	6.596	20.715	6.715	30.174
12/22/2004	22:28:05	109.5192	23.567	6.567	20.672	6.672	30.171
12/22/2004	22:30:05	111.5192	23.567	6.567	20.658	6.658	30.169
12/22/2004	22:32:05	113.5192	23.509	6.509	20.615	6.615	30.169
12/22/2004	22:34:05	115.5192	23.48	6.48	20.601	6.601	30.169
12/22/2004	22:36:05	117.5192	23.452	6.452	20.572	6.572	30.167
12/22/2004	22:38:05	119.5192	23.437	6.437	20.543	6.543	30.167
12/22/2004	22:40:05	121.5192	23.408	6.408	20.529	6.529	30.169

12/22/2004	22:42:05	123.5192	23.38	6.38	20.5	6.5	30.169
12/22/2004	22:44:05	125.5192	23.351	6.351	20.472	6.472	30.167
12/22/2004	22:46:05	127.5192	23.322	6.322	20.443	6.443	30.167
12/22/2004	22:48:05	129.5192	23.308	6.308	20.429	6.429	30.169
12/22/2004	22:50:05	131.5192	23.279	6.279	20.4	6.4	30.171
12/22/2004	22:52:05	133.5192	23.25	6.25	20.371	6.371	30.174
12/22/2004	22:54:05	135.5192	23.25	6.25	20.343	6.343	30.174
12/22/2004	22:56:05	137.5192	23.221	6.221	20.314	6.314	30.171
12/22/2004	22:58:05	139.5192	23.192	6.192	20.285	6.285	30.174
12/22/2004	23:00:05	141.5192	23.178	6.178	20.257	6.257	30.171
12/22/2004	23:02:05	143.5192	23.163	6.163	20.242	6.242	30.171
12/22/2004	23:04:05	145.5192	23.12	6.12	20.228	6.228	30.171
12/22/2004	23:06:05	147.5192	23.12	6.12	20.199	6.199	30.174
12/22/2004	23:08:05	149.5192	23.077	6.077	20.185	6.185	30.176
12/22/2004	23:10:05	151.5192	23.048	6.048	20.171	6.171	30.174
12/22/2004	23:12:05	153.5192	23.034	6.034	20.142	6.142	30.176
12/22/2004	23:14:05	155.5192	23.019	6.019	20.113	6.113	30.171
12/22/2004	23:16:05	157.5192	22.991	5.991	20.085	6.085	30.171
12/22/2004	23:18:05	159.5192	22.976	5.976	20.07	6.07	30.169
12/22/2004	23:20:05	161.5192	22.947	5.947	20.042	6.042	30.169
12/22/2004	23:22:05	163.5192	22.918	5.918	20.027	6.027	30.167
12/22/2004	23:24:05	165.5192	22.904	5.904	19.999	5.999	30.163
12/22/2004	23:26:05	167.5192	22.875	5.875	19.984	5.984	30.161
12/22/2004	23:28:05	169.5192	22.861	5.861	19.956	5.956	30.159
12/22/2004	23:30:05	171.5192	22.846	5.846	19.941	5.941	30.159
12/22/2004	23:32:05	173.5192	22.832	5.832	19.927	5.927	30.157
12/22/2004	23:34:05	175.5192	22.803	5.803	19.913	5.913	30.159
12/22/2004	23:36:05	177.5192	22.789	5.789	19.898	5.898	30.159
12/22/2004	23:38:05	179.5192	22.774	5.774	19.855	5.855	30.159
12/22/2004	23:40:05	181.5192	22.746	5.746	19.841	5.841	30.159
12/22/2004	23:42:05	183.5192	22.717	5.717	19.812	5.812	30.159
12/22/2004	23:44:05	185.5192	22.688	5.688	19.784	5.784	30.157
12/22/2004	23:46:05	187.5192	22.688	5.688	19.769	5.769	30.153
12/22/2004	23:48:05	189.5192	22.659	5.659	19.755	5.755	30.149
12/22/2004	23:50:05	191.5192	22.616	5.616	19.726	5.726	30.147
12/22/2004	23:52:05	193.5192	22.616	5.616	19.712	5.712	30.147
12/22/2004	23:54:05	195.5192	22.587	5.587	19.683	5.683	30.145
12/22/2004	23:56:05	197.5192	22.573	5.573	19.669	5.669	30.145
12/22/2004	23:58:05	199.5192	22.558	5.558	19.655	5.655	30.145
12/23/2004	0:00:05	201.5192	22.544	5.544	19.64	5.64	30.145
12/23/2004	0:02:05	203.5192	22.529	5.529	19.626	5.626	30.143
12/23/2004	0:04:05	205.5192	22.515	5.515	19.612	5.612	30.141
12/23/2004	0:06:05	207.5192	22.486	5.486	19.597	5.597	30.139
12/23/2004	0:08:05	209.5192	22.472	5.472	19.569	5.569	30.139
12/23/2004	0:10:05	211.5192	22.457	5.457	19.554	5.554	30.137
12/23/2004	0:12:05	213.5192	22.443	5.443	19.511	5.511	30.135
12/23/2004	0:14:05	215.5192	22.4	5.4	19.497	5.497	30.135
12/23/2004	0:16:05	217.5192	22.371	5.371	19.483	5.483	30.133
12/23/2004	0:18:05	219.5192	22.371	5.371	19.468	5.468	30.129
12/23/2004	0:20:05	221.5192	22.342	5.342	19.454	5.454	30.131
12/23/2004	0:22:05	223.5192	22.328	5.328	19.425	5.425	30.131
12/23/2004	0:24:05	225.5192	22.299	5.299	19.411	5.411	30.131

12/23/2004	0:26:05	227.5192	22.299	5.299	19.397	5.397	30.129
12/23/2004	0:28:05	229.5192	22.284	5.284	19.382	5.382	30.129
12/23/2004	0:30:05	231.5192	22.27	5.27	19.354	5.354	30.127
12/23/2004	0:32:05	233.5192	22.241	5.241	19.339	5.339	30.125
12/23/2004	0:34:05	235.5192	22.227	5.227	19.325	5.325	30.123
12/23/2004	0:36:05	237.5192	22.184	5.184	19.296	5.296	30.119
12/23/2004	0:38:05	239.5192	22.198	5.198	19.296	5.296	30.119
12/23/2004	0:40:05	241.5192	22.155	5.155	19.268	5.268	30.119
12/23/2004	0:42:05	243.5192	22.126	5.126	19.253	5.253	30.121
12/23/2004	0:44:05	245.5192	22.126	5.126	19.239	5.239	30.119
12/23/2004	0:46:05	247.5192	22.111	5.111	19.225	5.225	30.119
12/23/2004	0:48:05	249.5192	22.083	5.083	19.21	5.21	30.117
12/23/2004	0:50:05	251.5192	22.068	5.068	19.182	5.182	30.114
12/23/2004	0:52:05	253.5192	22.054	5.054	19.167	5.167	30.112
12/23/2004	0:54:05	255.5192	22.025	5.025	19.139	5.139	30.11
12/23/2004	0:56:05	257.5192	22.025	5.025	19.139	5.139	30.11
12/23/2004	0:58:05	259.5192	22.011	5.011	19.124	5.124	30.11
12/23/2004	1:00:05	261.5192	22.011	5.011	19.081	5.081	30.11
12/23/2004	1:02:05	263.5192	21.967	4.967	19.067	5.067	30.108
12/23/2004	1:04:05	265.5192	21.967	4.967	19.053	5.053	30.11
12/23/2004	1:06:05	267.5192	21.953	4.953	19.024	5.024	30.11
12/23/2004	1:08:05	269.5192	21.91	4.91	19.01	5.01	30.108
12/23/2004	1:10:05	271.5192	21.91	4.91	18.995	4.995	30.108
12/23/2004	1:12:05	273.5192	21.895	4.895	18.967	4.967	30.108
12/23/2004	1:14:05	275.5192	21.881	4.881	18.952	4.952	30.104
12/23/2004	1:16:05	277.5192	21.867	4.867	18.952	4.952	30.104
12/23/2004	1:18:05	279.5192	21.852	4.852	18.938	4.938	30.106
12/23/2004	1:20:05	281.5192	21.838	4.838	18.909	4.909	30.106
12/23/2004	1:22:05	283.5192	21.809	4.809	18.881	4.881	30.106
12/23/2004	1:24:05	285.5192	21.78	4.78	18.866	4.866	30.106
12/23/2004	1:26:05	287.5192	21.78	4.78	18.852	4.852	30.106
12/23/2004	1:28:05	289.5192	21.766	4.766	18.838	4.838	30.106
12/23/2004	1:30:05	291.5192	21.751	4.751	18.838	4.838	30.106
12/23/2004	1:32:05	293.5192	21.737	4.737	18.809	4.809	30.108
12/23/2004	1:34:05	295.5192	21.708	4.708	18.795	4.795	30.106
12/23/2004	1:36:05	297.5192	21.694	4.694	18.78	4.78	30.104
12/23/2004	1:38:05	299.5192	21.665	4.665	18.78	4.78	30.106
12/23/2004	1:40:05	301.5192	21.665	4.665	18.752	4.752	30.104
12/23/2004	1:42:05	303.5192	21.65	4.65	18.737	4.737	30.104
12/23/2004	1:44:05	305.5192	21.636	4.636	18.709	4.709	30.104
12/23/2004	1:46:05	307.5192	21.622	4.622	18.694	4.694	30.106
12/23/2004	1:48:05	309.5192	21.593	4.593	18.68	4.68	30.106
12/23/2004	1:50:05	311.5192	21.564	4.564	18.666	4.666	30.106
12/23/2004	1:52:05	313.5192	21.549	4.549	18.651	4.651	30.108
12/23/2004	1:54:05	315.5192	21.564	4.564	18.623	4.623	30.108
12/23/2004	1:56:05	317.5192	21.549	4.549	18.608	4.608	30.108
12/23/2004	1:58:05	319.5192	21.506	4.506	18.594	4.594	30.11
12/23/2004	2:00:05	321.5192	21.492	4.492	18.58	4.58	30.114
12/23/2004	2:02:05	323.5192	21.492	4.492	18.551	4.551	30.114
12/23/2004	2:04:05	325.5192	21.477	4.477	18.537	4.537	30.117
12/23/2004	2:06:05	327.5192	21.463	4.463	18.508	4.508	30.112
12/23/2004	2:08:05	329.5192	21.405	4.405	18.508	4.508	30.119



12/23/2004	2:10:05	331.5192	21.434	4.434	18.479	4.479	30.123
12/23/2004	2:12:05	333.5192	21.377	4.377	18.465	4.465	30.119
12/23/2004	2:14:05	335.5192	21.377	4.377	18.451	4.451	30.119
12/23/2004	2:16:05	337.5192	21.362	4.362	18.422	4.422	30.121
12/23/2004	2:18:05	339.5192	21.333	4.333	18.422	4.422	30.119
12/23/2004	2:20:05	341.5192	21.304	4.304	18.408	4.408	30.117
12/23/2004	2:22:05	343.5192	21.29	4.29	18.379	4.379	30.112
12/23/2004	2:24:05	345.5192	21.276	4.276	18.365	4.365	30.11
12/23/2004	2:26:05	347.5192	21.276	4.276	18.336	4.336	30.106
12/23/2004	2:28:05	349.5192	21.261	4.261	18.307	4.307	30.102
12/23/2004	2:30:05	351.5192	21.218	4.218	18.293	4.293	30.098
12/23/2004	2:32:05	353.5192	21.204	4.204	18.279	4.279	30.096
12/23/2004	2:34:05	355.5192	21.204	4.204	18.264	4.264	30.092
12/23/2004	2:36:05	357.5192	21.175	4.175	18.236	4.236	30.086
12/23/2004	2:38:05	359.5192	21.16	4.16	18.221	4.221	30.086
12/23/2004	2:40:05	361.5192	21.146	4.146	18.221	4.221	30.088
12/23/2004	2:42:05	363.5192	21.146	4.146	18.193	4.193	30.088
12/23/2004	2:44:05	365.5192	21.117	4.117	18.178	4.178	30.088
12/23/2004	2:46:05	367.5192	21.103	4.103	18.164	4.164	30.088
12/23/2004	2:48:05	369.5192	21.074	4.074	18.15	4.15	30.092
12/23/2004	2:50:05	371.5192	21.074	4.074	18.135	4.135	30.092
12/23/2004	2:52:05	373.5192	21.074	4.074	18.135	4.135	30.09
12/23/2004	2:54:05	375.5192	21.045	4.045	18.107	4.107	30.09
12/23/2004	2:56:05	377.5192	21.031	4.031	18.092	4.092	30.086
12/23/2004	2:58:05	379.5192	21.016	4.016	18.078	4.078	30.084
12/23/2004	3:00:05	381.5192	20.973	3.973	18.064	4.064	30.082
12/23/2004	3:02:05	383.5192	20.973	3.973	18.035	4.035	30.082
12/23/2004	3:04:05	385.5192	21.002	4.002	18.049	4.049	30.08
12/23/2004	3:06:05	387.5192	20.944	3.944	18.021	4.021	30.08
12/23/2004	3:08:05	389.5192	20.93	3.93	18.006	4.006	30.082
12/23/2004	3:10:05	391.5192	20.93	3.93	18.006	4.006	30.082
12/23/2004	3:12:05	393.5192	20.901	3.901	17.992	3.992	30.078
12/23/2004	3:14:05	395.5192	20.887	3.887	17.963	3.963	30.074
12/23/2004	3:16:05	397.5192	20.887	3.887	17.949	3.949	30.072
12/23/2004	3:18:05	399.5192	20.872	3.872	17.935	3.935	30.068
12/23/2004	3:20:05	401.5192	20.829	3.829	17.92	3.92	30.066
12/23/2004	3:22:05	403.5192	20.815	3.815	17.892	3.892	30.064
12/23/2004	3:24:05	405.5192	20.829	3.829	17.877	3.877	30.062
12/23/2004	3:26:05	407.5192	20.786	3.786	17.863	3.863	30.06
12/23/2004	3:28:05	409.5192	20.786	3.786	17.849	3.849	30.062
12/23/2004	3:30:05	411.5192	20.771	3.771	17.82	3.82	30.057
12/23/2004	3:32:05	413.5192	20.757	3.757	17.82	3.82	30.057
12/23/2004	3:34:05	415.5192	20.742	3.742	17.806	3.806	30.057
12/23/2004	3:36:05	417.5192	20.742	3.742	17.791	3.791	30.055
12/23/2004	3:38:05	419.5192	20.714	3.714	17.791	3.791	30.055
12/23/2004	3:40:05	421.5192	20.699	3.699	17.777	3.777	30.055
12/23/2004	3:42:05	423.5192	20.699	3.699	17.763	3.763	30.055
12/23/2004	3:44:05	425.5192	20.67	3.67	17.748	3.748	30.057
12/23/2004	3:46:05	427.5192	20.67	3.67	17.72	3.72	30.053
12/23/2004	3:48:05	429.5192	20.642	3.642	17.705	3.705	30.053
12/23/2004	3:50:05	431.5192	20.642	3.642	17.705	3.705	30.051
12/23/2004	3:52:05	433.5192	20.627	3.627	17.677	3.677	30.047

12/23/2004	3:54:05	435.5192	20.613	3.613	17.662	3.662	30.049
12/23/2004	3:56:05	437.5192	20.598	3.598	17.648	3.648	30.049
12/23/2004	3:58:05	439.5192	20.584	3.584	17.634	3.634	30.047
12/23/2004	4:00:05	441.5192	20.57	3.57	17.634	3.634	30.045
12/23/2004	4:02:05	443.5192	20.584	3.584	17.619	3.619	30.047
12/23/2004	4:04:05	445.5192	20.555	3.555	17.605	3.605	30.047
12/23/2004	4:06:05	447.5192	20.541	3.541	17.605	3.605	30.043
12/23/2004	4:08:05	449.5192	20.541	3.541	17.591	3.591	30.049
12/23/2004	4:10:05	451.5192	20.526	3.526	17.591	3.591	30.049
12/23/2004	4:12:05	453.5192	20.512	3.512	17.576	3.576	30.049
12/23/2004	4:14:05	455.5192	20.497	3.497	17.562	3.562	30.049
12/23/2004	4:16:05	457.5192	20.512	3.512	17.548	3.548	30.053
12/23/2004	4:18:05	459.5192	20.483	3.483	17.548	3.548	30.051
12/23/2004	4:20:05	461.5192	20.469	3.469	17.533	3.533	30.049
12/23/2004	4:22:05	463.5192	20.454	3.454	17.519	3.519	30.045
12/23/2004	4:24:05	465.5192	20.44	3.44	17.505	3.505	30.047
12/23/2004	4:26:05	467.5192	20.44	3.44	17.476	3.476	30.045
12/23/2004	4:28:05	469.5192	20.397	3.397	17.476	3.476	30.045
12/23/2004	4:30:05	471.5192	20.382	3.382	17.462	3.462	30.041
12/23/2004	4:32:05	473.5192	20.382	3.382	17.447	3.447	30.039
12/23/2004	4:34:05	475.5192	20.382	3.382	17.433	3.433	30.041
12/23/2004	4:36:05	477.5192	20.368	3.368	17.433	3.433	30.039
12/23/2004	4:38:05	479.5192	20.368	3.368	17.419	3.419	30.041
12/23/2004	4:40:05	481.5192	20.339	3.339	17.404	3.404	30.041
12/23/2004	4:42:05	483.5192	20.353	3.353	17.404	3.404	30.037
12/23/2004	4:44:05	485.5192	20.339	3.339	17.404	3.404	30.037
12/23/2004	4:46:05	487.5192	20.339	3.339	17.404	3.404	30.035
12/23/2004	4:48:05	489.5192	20.325	3.325	17.376	3.376	30.037
12/23/2004	4:50:05	491.5192	20.296	3.296	17.361	3.361	30.037
12/23/2004	4:52:05	493.5192	20.31	3.31	17.361	3.361	30.033
12/23/2004	4:54:05	495.5192	20.296	3.296	17.361	3.361	30.033
12/23/2004	4:56:05	497.5192	20.31	3.31	17.361	3.361	30.035
12/23/2004	4:58:05	499.5192	20.31	3.31	17.361	3.361	30.033
12/23/2004	5:00:05	501.5192	20.296	3.296	17.347	3.347	30.031
12/23/2004	5:02:05	503.5192	20.281	3.281	17.347	3.347	30.033
12/23/2004	5:04:05	505.5192	20.252	3.252	17.333	3.333	30.029
12/23/2004	5:06:05	507.5192	20.267	3.267	17.333	3.333	30.029
12/23/2004	5:08:05	509.5192	20.267	3.267	17.318	3.318	30.027
12/23/2004	5:10:05	511.5192	20.224	3.224	17.318	3.318	30.027
12/23/2004	5:12:05	513.5192	20.238	3.238	17.304	3.304	30.025
12/23/2004	5:14:05	515.5192	20.224	3.224	17.275	3.275	30.021
12/23/2004	5:16:05	517.5192	20.195	3.195	17.261	3.261	30.019
12/23/2004	5:18:05	519.5192	20.166	3.166	17.232	3.232	30.019
12/23/2004	5:20:05	521.5192	20.18	3.18	17.218	3.218	30.019
12/23/2004	5:22:05	523.5192	20.166	3.166	17.204	3.204	30.017
12/23/2004	5:24:05	525.5192	20.137	3.137	17.189	3.189	30.015
12/23/2004	5:26:05	527.5192	20.152	3.152	17.189	3.189	30.017
12/23/2004	5:28:05	529.5192	20.137	3.137	17.189	3.189	30.015
12/23/2004	5:30:05	531.5192	20.123	3.123	17.189	3.189	30.013
12/23/2004	5:32:05	533.5192	20.123	3.123	17.175	3.175	30.013
12/23/2004	5:34:05	535.5192	20.123	3.123	17.189	3.189	30.015
12/23/2004	5:36:05	537.5192	20.123	3.123	17.189	3.189	30.015

12/23/2004	5:38:05	539.5192	20.094	3.094	17.189	3.189	30.011
12/23/2004	5:40:05	541.5192	20.08	3.08	17.16	3.16	30.011
12/23/2004	5:42:05	543.5192	20.08	3.08	17.16	3.16	30.011
12/23/2004	5:44:05	545.5192	20.08	3.08	17.146	3.146	30.011
12/23/2004	5:46:05	547.5192	20.08	3.08	17.16	3.16	30.013
12/23/2004	5:48:05	549.5192	20.08	3.08	17.16	3.16	30.013
12/23/2004	5:50:05	551.5192	20.08	3.08	17.16	3.16	30.015
12/23/2004	5:52:05	553.5192	20.065	3.065	17.132	3.132	30.015
12/23/2004	5:54:05	555.5192	20.051	3.051	17.146	3.146	30.013
12/23/2004	5:56:05	557.5192	20.051	3.051	17.146	3.146	30.013
12/23/2004	5:58:05	559.5192	20.051	3.051	17.117	3.117	30.011
12/23/2004	6:00:05	561.5192	20.051	3.051	17.103	3.103	30.013
12/23/2004	6:02:05	563.5192	20.051	3.051	17.103	3.103	30.013
12/23/2004	6:04:05	565.5192	20.036	3.036	17.103	3.103	30.019
12/23/2004	6:06:05	567.5192	20.051	3.051	17.089	3.089	30.015
12/23/2004	6:08:05	569.5192	20.022	3.022	17.089	3.089	30.017
12/23/2004	6:10:05	571.5192	20.022	3.022	17.089	3.089	30.015
12/23/2004	6:12:05	573.5192	20.022	3.022	17.089	3.089	30.017
12/23/2004	6:14:05	575.5192	20.022	3.022	17.089	3.089	30.015
12/23/2004	6:16:05	577.5192	20.022	3.022	17.089	3.089	30.015
12/23/2004	6:18:05	579.5192	20.008	3.008	17.074	3.074	30.017
12/23/2004	6:20:05	581.5192	19.979	2.979	17.06	3.06	30.015
12/23/2004	6:22:05	583.5192	19.979	2.979	17.06	3.06	30.011
12/23/2004	6:24:05	585.5192	19.964	2.964	17.06	3.06	30.013
12/23/2004	6:26:05	587.5192	19.993	2.993	17.06	3.06	30.015
12/23/2004	6:28:05	589.5192	19.993	2.993	17.06	3.06	30.015
12/23/2004	6:30:05	591.5192	19.979	2.979	17.06	3.06	30.015
12/23/2004	6:32:05	593.5192	19.979	2.979	17.074	3.074	30.013
12/23/2004	6:34:05	595.5192	19.979	2.979	17.074	3.074	30.015
12/23/2004	6:36:05	597.5192	19.964	2.964	17.06	3.06	30.017
12/23/2004	6:38:05	599.5192	19.964	2.964	17.06	3.06	30.015
12/23/2004	6:40:05	601.5192	19.964	2.964	17.046	3.046	30.017
12/23/2004	6:42:05	603.5192	19.95	2.95	17.031	3.031	30.017
12/23/2004	6:44:05	605.5192	19.935	2.935	17.031	3.031	30.017
12/23/2004	6:46:05	607.5192	19.95	2.95	17.031	3.031	30.019
12/23/2004	6:48:05	609.5192	19.935	2.935	17.017	3.017	30.011
12/23/2004	6:50:05	611.5192	19.921	2.921	17.017	3.017	30.011
12/23/2004	6:52:05	613.5192	19.921	2.921	17.017	3.017	30.011
12/23/2004	6:54:05	615.5192	19.921	2.921	17.017	3.017	30.015
12/23/2004	6:56:05	617.5192	19.921	2.921	17.017	3.017	30.009
12/23/2004	6:58:05	619.5192	19.95	2.95	17.017	3.017	30.009
12/23/2004	7:00:05	621.5192	19.921	2.921	17.017	3.017	30.011
12/23/2004	7:02:05	623.5192	19.921	2.921	17.017	3.017	30.009
12/23/2004	7:04:05	625.5192	19.921	2.921	17.017	3.017	30.011
12/23/2004	7:06:05	627.5192	19.935	2.935	17.017	3.017	30.005
12/23/2004	7:08:05	629.5192	19.921	2.921	17.017	3.017	30.002
12/23/2004	7:10:05	631.5192	19.921	2.921	17.017	3.017	30
12/23/2004	7:12:05	633.5192	19.921	2.921	17.031	3.031	29.998
12/23/2004	7:14:05	635.5192	19.907	2.907	17.003	3.003	29.998
12/23/2004	7:16:05	637.5192	19.892	2.892	16.988	2.988	29.998
12/23/2004	7:18:05	639.5192	19.907	2.907	16.988	2.988	30.002
12/23/2004	7:20:05	641.5192	19.892	2.892	17.003	3.003	30.002

12/23/2004	7:22:05	643.5192	19.892	2.892	16.988	2.988	30
12/23/2004	7:24:05	645.5192	19.921	2.921	17.003	3.003	30
12/23/2004	7:26:05	647.5192	19.892	2.892	16.988	2.988	29.998
12/23/2004	7:28:05	649.5192	19.892	2.892	16.988	2.988	29.998
12/23/2004	7:30:05	651.5192	19.878	2.878	16.974	2.974	29.996
12/23/2004	7:32:05	653.5192	19.878	2.878	16.988	2.988	29.994
12/23/2004	7:34:05	655.5192	19.892	2.892	16.988	2.988	29.994
12/23/2004	7:36:05	657.5192	19.878	2.878	16.988	2.988	29.992
12/23/2004	7:38:05	659.5192	19.892	2.892	16.974	2.974	29.99
12/23/2004	7:40:05	661.5192	19.878	2.878	16.988	2.988	29.982
12/23/2004	7:42:05	663.5192	19.878	2.878	16.974	2.974	29.988
12/23/2004	7:44:05	665.5192	19.878	2.878	16.974	2.974	29.988
12/23/2004	7:46:05	667.5192	19.863	2.863	16.974	2.974	29.992
12/23/2004	7:48:05	669.5192	19.863	2.863	16.974	2.974	29.994
12/23/2004	7:50:05	671.5192	19.878	2.878	16.988	2.988	29.988
12/23/2004	7:52:05	673.5192	19.892	2.892	16.988	2.988	29.99
12/23/2004	7:54:05	675.5192	19.878	2.878	16.988	2.988	29.99
12/23/2004	7:56:05	677.5192	19.892	2.892	16.988	2.988	29.988
12/23/2004	7:58:05	679.5192	19.892	2.892	17.003	3.003	29.988
12/23/2004	8:00:05	681.5192	19.878	2.878	17.003	3.003	29.988
12/23/2004	8:02:05	683.5192	19.892	2.892	17.003	3.003	29.986
12/23/2004	8:04:05	685.5192	19.892	2.892	17.003	3.003	29.986
12/23/2004	8:06:05	687.5192	19.892	2.892	17.003	3.003	29.986
12/23/2004	8:08:05	689.5192	19.907	2.907	17.017	3.017	29.986
12/23/2004	8:10:05	691.5192	19.892	2.892	17.017	3.017	29.988
12/23/2004	8:12:05	693.5192	19.907	2.907	17.031	3.031	29.986
12/23/2004	8:14:05	695.5192	19.892	2.892	17.017	3.017	29.984
12/23/2004	8:16:05	697.5192	19.892	2.892	17.017	3.017	29.982
12/23/2004	8:18:05	699.5192	19.892	2.892	17.031	3.031	29.978
12/23/2004	8:20:05	701.5192	19.892	2.892	17.031	3.031	29.98
12/23/2004	8:22:05	703.5192	19.907	2.907	17.031	3.031	29.978
12/23/2004	8:24:05	705.5192	19.907	2.907	17.031	3.031	29.976
12/23/2004	8:26:05	707.5192	19.921	2.921	17.046	3.046	29.978
12/23/2004	8:28:05	709.5192	19.921	2.921	17.031	3.031	29.976
12/23/2004	8:30:05	711.5192	19.935	2.935	17.031	3.031	29.976
12/23/2004	8:32:05	713.5192	19.921	2.921	17.046	3.046	29.978
12/23/2004	8:34:05	715.5192	19.907	2.907	17.046	3.046	29.976
12/23/2004	8:36:05	717.5192	19.921	2.921	17.06	3.06	29.98
12/23/2004	8:38:05	719.5192	19.921	2.921	17.06	3.06	29.98
12/23/2004	8:40:05	721.5192	19.921	2.921	17.046	3.046	29.982
12/23/2004	8:42:05	723.5192	19.921	2.921	17.06	3.06	29.982
12/23/2004	8:44:05	725.5192	19.921	2.921	17.046	3.046	29.984
12/23/2004	8:46:05	727.5192	19.921	2.921	17.06	3.06	29.984
12/23/2004	8:48:05	729.5192	19.935	2.935	17.06	3.06	29.982
12/23/2004	8:50:05	731.5192	19.935	2.935	17.074	3.074	29.982
12/23/2004	8:52:05	733.5192	19.935	2.935	17.074	3.074	29.984
12/23/2004	8:54:05	735.5192	19.935	2.935	17.074	3.074	29.982
12/23/2004	8:56:05	737.5192	19.95	2.95	17.074	3.074	29.98
12/23/2004	8:58:05	739.5192	19.95	2.95	17.074	3.074	29.98
12/23/2004	9:00:05	741.5192	19.95	2.95	17.074	3.074	29.976
12/23/2004	9:02:05	743.5192	19.95	2.95	17.074	3.074	29.974
12/23/2004	9:04:05	745.5192	19.95	2.95	17.089	3.089	29.974

12/23/2004	9:06:05	747.5192	19.95	2.95	17.089	3.089	29.974
12/23/2004	9:08:05	749.5192	19.95	2.95	17.074	3.074	29.972
12/23/2004	9:10:05	751.5192	19.95	2.95	17.089	3.089	29.97
12/23/2004	9:12:05	753.5192	19.935	2.935	17.074	3.074	29.974
12/23/2004	9:14:05	755.5192	19.95	2.95	17.089	3.089	29.972
12/23/2004	9:16:05	757.5192	19.95	2.95	17.074	3.074	29.97
12/23/2004	9:18:05	759.5192	19.95	2.95	17.103	3.103	29.968
12/23/2004	9:20:05	761.5192	19.964	2.964	17.089	3.089	29.968
12/23/2004	9:22:05	763.5192	19.964	2.964	17.089	3.089	29.972
12/23/2004	9:24:05	765.5192	19.964	2.964	17.103	3.103	29.97
12/23/2004	9:26:05	767.5192	19.964	2.964	17.103	3.103	29.966
12/23/2004	9:28:05	769.5192	19.964	2.964	17.103	3.103	29.966
12/23/2004	9:30:05	771.5192	19.964	2.964	17.089	3.089	29.968
12/23/2004	9:32:05	773.5192	19.964	2.964	17.089	3.089	29.964
12/23/2004	9:34:05	775.5192	19.964	2.964	17.103	3.103	29.966
12/23/2004	9:36:05	777.5192	19.979	2.979	17.103	3.103	29.966
12/23/2004	9:38:05	779.5192	19.979	2.979	17.117	3.117	29.964
12/23/2004	9:40:05	781.5192	19.993	2.993	17.117	3.117	29.964
12/23/2004	9:42:05	783.5192	19.993	2.993	17.132	3.132	29.968
12/23/2004	9:44:05	785.5192	19.993	2.993	17.132	3.132	29.966
12/23/2004	9:46:05	787.5192	19.993	2.993	17.132	3.132	29.964
12/23/2004	9:48:05	789.5192	20.008	3.008	17.132	3.132	29.966
12/23/2004	9:50:05	791.5192	20.022	3.022	17.132	3.132	29.966
12/23/2004	9:52:05	793.5192	19.979	2.979	17.132	3.132	29.962
12/23/2004	9:54:05	795.5192	19.979	2.979	17.132	3.132	29.962
12/23/2004	9:56:05	797.5192	20.022	3.022	17.132	3.132	29.962
12/23/2004	9:58:05	799.5192	19.993	2.993	17.146	3.146	29.966
12/23/2004	10:00:05	801.5192	19.993	2.993	17.146	3.146	29.968
12/23/2004	10:02:05	803.5192	19.993	2.993	17.146	3.146	29.968
12/23/2004	10:04:05	805.5192	19.993	2.993	17.146	3.146	29.97
12/23/2004	10:06:05	807.5192	19.993	2.993	17.132	3.132	29.97
12/23/2004	10:08:05	809.5192	19.993	2.993	17.146	3.146	29.966
12/23/2004	10:10:05	811.5192	19.993	2.993	17.146	3.146	29.964
12/23/2004	10:12:05	813.5192	19.993	2.993	17.146	3.146	29.964
12/23/2004	10:14:05	815.5192	20.008	3.008	17.146	3.146	29.966
12/23/2004	10:16:05	817.5192	20.008	3.008	17.146	3.146	29.964
12/23/2004	10:18:05	819.5192	19.993	2.993	17.146	3.146	29.962
12/23/2004	10:20:05	821.5192	20.008	3.008	17.16	3.16	29.962
12/23/2004	10:22:05	823.5192	20.008	3.008	17.16	3.16	29.962
12/23/2004	10:24:05	825.5192	20.008	3.008	17.16	3.16	29.962
12/23/2004	10:26:05	827.5192	20.008	3.008	17.146	3.146	29.962
12/23/2004	10:28:05	829.5192	20.008	3.008	17.16	3.16	29.962
12/23/2004	10:30:05	831.5192	20.036	3.036	17.16	3.16	29.964
12/23/2004	10:32:05	833.5192	20.022	3.022	17.16	3.16	29.964
12/23/2004	10:34:05	835.5192	20.008	3.008	17.146	3.146	29.96
12/23/2004	10:36:05	837.5192	20.008	3.008	17.146	3.146	29.962
12/23/2004	10:38:05	839.5192	20.022	3.022	17.16	3.16	29.958
12/23/2004	10:40:05	841.5192	20.008	3.008	17.16	3.16	29.954
12/23/2004	10:42:05	843.5192	20.022	3.022	17.16	3.16	29.954
12/23/2004	10:44:05	845.5192	20.022	3.022	17.175	3.175	29.952
12/23/2004	10:46:05	847.5192	20.022	3.022	17.175	3.175	29.95
12/23/2004	10:48:05	849.5192	20.022	3.022	17.175	3.175	29.948

12/23/2004	10:50:05	851.5192	20.022	3.022	17.189	3.189	29.948
12/23/2004	10:52:05	853.5192	20.022	3.022	17.175	3.175	29.943
12/23/2004	10:54:05	855.5192	20.022	3.022	17.16	3.16	29.943
12/23/2004	10:56:05	857.5192	20.008	3.008	17.16	3.16	29.945
12/23/2004	10:58:05	859.5192	20.022	3.022	17.16	3.16	29.941
12/23/2004	11:00:05	861.5192	20.008	3.008	17.16	3.16	29.939
12/23/2004	11:02:05	863.5192	20.008	3.008	17.16	3.16	29.939
12/23/2004	11:04:05	865.5192	20.022	3.022	17.16	3.16	29.937
12/23/2004	11:06:05	867.5192	20.008	3.008	17.146	3.146	29.937
12/23/2004	11:08:05	869.5192	20.008	3.008	17.16	3.16	29.935
12/23/2004	11:10:05	871.5192	20.008	3.008	17.16	3.16	29.937
12/23/2004	11:12:05	873.5192	20.008	3.008	17.16	3.16	29.933
12/23/2004	11:14:05	875.5192	20.008	3.008	17.16	3.16	29.935
12/23/2004	11:16:05	877.5192	20.008	3.008	17.16	3.16	29.937
12/23/2004	11:18:05	879.5192	19.993	2.993	17.16	3.16	29.937
12/23/2004	11:20:05	881.5192	20.008	3.008	17.16	3.16	29.933
12/23/2004	11:22:05	883.5192	19.993	2.993	17.16	3.16	29.931
12/23/2004	11:24:05	885.5192	20.008	3.008	17.16	3.16	29.929
12/23/2004	11:26:05	887.5192	20.022	3.022	17.16	3.16	29.925
12/23/2004	11:28:05	889.5192	20.022	3.022	17.16	3.16	29.923
12/23/2004	11:30:05	891.5192	20.008	3.008	17.16	3.16	29.923
12/23/2004	11:32:05	893.5192	20.008	3.008	17.16	3.16	29.923
12/23/2004	11:34:05	895.5192	20.022	3.022	17.16	3.16	29.919
12/23/2004	11:36:05	897.5192	19.993	2.993	17.146	3.146	29.917
12/23/2004	11:38:05	899.5192	20.022	3.022	17.16	3.16	29.915
12/23/2004	11:40:05	901.5192	19.993	2.993	17.146	3.146	29.915
12/23/2004	11:42:05	903.5192	20.022	3.022	17.146	3.146	29.913
12/23/2004	11:44:05	905.5192	20.008	3.008	17.146	3.146	29.915
12/23/2004	11:46:05	907.5192	20.022	3.022	17.146	3.146	29.913
12/23/2004	11:48:05	909.5192	20.008	3.008	17.146	3.146	29.909
12/23/2004	11:50:05	911.5192	19.993	2.993	17.146	3.146	29.907
12/23/2004	11:52:05	913.5192	19.993	2.993	17.146	3.146	29.905
12/23/2004	11:54:05	915.5192	19.979	2.979	17.132	3.132	29.903
12/23/2004	11:56:05	917.5192	20.008	3.008	17.132	3.132	29.903
12/23/2004	11:58:05	919.5192	19.979	2.979	17.132	3.132	29.905
12/23/2004	12:00:05	921.5192	19.979	2.979	17.146	3.146	29.903
12/23/2004	12:02:05	923.5192	19.979	2.979	17.132	3.132	29.903
12/23/2004	12:04:05	925.5192	19.979	2.979	17.132	3.132	29.901
12/23/2004	12:06:05	927.5192	19.979	2.979	17.132	3.132	29.899
12/23/2004	12:08:05	929.5192	19.993	2.993	17.132	3.132	29.899
12/23/2004	12:10:05	931.5192	19.979	2.979	17.117	3.117	29.897
12/23/2004	12:12:05	933.5192	19.993	2.993	17.132	3.132	29.895
12/23/2004	12:14:05	935.5192	19.979	2.979	17.117	3.117	29.895
12/23/2004	12:16:05	937.5192	19.964	2.964	17.117	3.117	29.895
12/23/2004	12:18:05	939.5192	19.964	2.964	17.117	3.117	29.895
12/23/2004	12:20:05	941.5192	19.964	2.964	17.117	3.117	29.893
12/23/2004	12:22:05	943.5192	19.964	2.964	17.117	3.117	29.893
12/23/2004	12:24:05	945.5192	19.979	2.979	17.132	3.132	29.895
12/23/2004	12:26:05	947.5192	19.964	2.964	17.117	3.117	29.895
12/23/2004	12:28:05	949.5192	19.964	2.964	17.103	3.103	29.893
12/23/2004	12:30:05	951.5192	19.964	2.964	17.103	3.103	29.891
12/23/2004	12:32:05	953.5192	19.95	2.95	17.103	3.103	29.891

12/23/2004	12:34:05	955.5192	19.964	2.964	17.089	3.089	29.893
12/23/2004	12:36:05	957.5192	19.935	2.935	17.089	3.089	29.893
12/23/2004	12:38:05	959.5192	19.964	2.964	17.089	3.089	29.888
12/23/2004	12:40:05	961.5192	19.964	2.964	17.089	3.089	29.888
12/23/2004	12:42:05	963.5192	19.964	2.964	17.089	3.089	29.891
12/23/2004	12:44:05	965.5192	19.935	2.935	17.089	3.089	29.893
12/23/2004	12:46:05	967.5192	19.95	2.95	17.089	3.089	29.888
12/23/2004	12:48:05	969.5192	19.921	2.921	17.06	3.06	29.886
12/23/2004	12:50:05	971.5192	19.921	2.921	17.046	3.046	29.886
12/23/2004	12:52:05	973.5192	19.935	2.935	17.046	3.046	29.886
12/23/2004	12:54:05	975.5192	19.921	2.921	17.046	3.046	29.882
12/23/2004	12:56:05	977.5192	19.921	2.921	17.031	3.031	29.882
12/23/2004	12:58:05	979.5192	19.892	2.892	17.046	3.046	29.882
12/23/2004	13:00:05	981.5192	19.921	2.921	17.046	3.046	29.882
12/23/2004	13:02:05	983.5192	19.892	2.892	17.031	3.031	29.876
12/23/2004	13:04:05	985.5192	19.878	2.878	17.031	3.031	29.874
12/23/2004	13:06:05	987.5192	19.892	2.892	17.017	3.017	29.874
12/23/2004	13:08:05	989.5192	19.892	2.892	17.031	3.031	29.876
12/23/2004	13:10:05	991.5192	19.878	2.878	17.017	3.017	29.874
12/23/2004	13:12:05	993.5192	19.863	2.863	17.003	3.003	29.874
12/23/2004	13:14:05	995.5192	19.849	2.849	17.003	3.003	29.874
12/23/2004	13:16:05	997.5192	19.878	2.878	17.003	3.003	29.872
12/23/2004	13:18:05	999.5192	19.863	2.863	16.988	2.988	29.868
12/23/2004	13:20:05	1001.519	19.849	2.849	17.003	3.003	29.868
12/23/2004	13:22:05	1003.519	19.849	2.849	17.003	3.003	29.868
12/23/2004	13:24:05	1005.519	19.835	2.835	16.988	2.988	29.868
12/23/2004	13:26:05	1007.519	19.863	2.863	16.974	2.974	29.868
12/23/2004	13:28:05	1009.519	19.849	2.849	16.96	2.96	29.87
12/23/2004	13:30:05	1011.519	19.849	2.849	16.96	2.96	29.866
12/23/2004	13:32:05	1013.519	19.835	2.835	16.96	2.96	29.862
12/23/2004	13:34:05	1015.519	19.806	2.806	16.945	2.945	29.86
12/23/2004	13:36:05	1017.519	19.806	2.806	16.931	2.931	29.864
12/23/2004	13:38:05	1019.519	19.82	2.82	16.931	2.931	29.864
12/23/2004	13:40:05	1021.519	19.791	2.791	16.931	2.931	29.862
12/23/2004	13:42:05	1023.519	19.806	2.806	16.931	2.931	29.86
12/23/2004	13:44:05	1025.519	19.791	2.791	16.917	2.917	29.862
12/23/2004	13:46:05	1027.519	19.791	2.791	16.917	2.917	29.86
12/23/2004	13:48:05	1029.519	19.791	2.791	16.917	2.917	29.86
12/23/2004	13:50:05	1031.519	19.777	2.777	16.917	2.917	29.86
12/23/2004	13:52:05	1033.519	19.763	2.763	16.902	2.902	29.852
12/23/2004	13:54:05	1035.519	19.748	2.748	16.888	2.888	29.85
12/23/2004	13:56:05	1037.519	19.748	2.748	16.874	2.874	29.85
12/23/2004	13:58:05	1039.519	19.763	2.763	16.874	2.874	29.848
12/23/2004	14:00:05	1041.519	19.748	2.748	16.874	2.874	29.844
12/23/2004	14:02:05	1043.519	19.748	2.748	16.859	2.859	29.844
12/23/2004	14:04:05	1045.519	19.734	2.734	16.859	2.859	29.844
12/23/2004	14:06:05	1047.519	19.748	2.748	16.859	2.859	29.844
12/23/2004	14:08:05	1049.519	19.748	2.748	16.859	2.859	29.848
12/23/2004	14:10:05	1051.519	19.734	2.734	16.845	2.845	29.844
12/23/2004	14:12:05	1053.519	19.734	2.734	16.845	2.845	29.846
12/23/2004	14:14:05	1055.519	19.719	2.719	16.845	2.845	29.846
12/23/2004	14:16:05	1057.519	19.734	2.734	16.831	2.831	29.848

12/23/2004	14:18:05	1059.519	19.69	2.69	16.831	2.831	29.846
12/23/2004	14:20:05	1061.519	19.69	2.69	16.816	2.816	29.848
12/23/2004	14:22:05	1063.519	19.705	2.705	16.802	2.802	29.848
12/23/2004	14:24:05	1065.519	19.676	2.676	16.788	2.788	29.85
12/23/2004	14:26:05	1067.519	19.676	2.676	16.788	2.788	29.85
12/23/2004	14:28:05	1069.519	19.662	2.662	16.773	2.773	29.85
12/23/2004	14:30:05	1071.519	19.662	2.662	16.773	2.773	29.848
12/23/2004	14:32:05	1073.519	19.676	2.676	16.773	2.773	29.85
12/23/2004	14:34:05	1075.519	19.662	2.662	16.759	2.759	29.848
12/23/2004	14:36:05	1077.519	19.662	2.662	16.759	2.759	29.846
12/23/2004	14:38:05	1079.519	19.662	2.662	16.745	2.745	29.846
12/23/2004	14:40:05	1081.519	19.633	2.633	16.745	2.745	29.844
12/23/2004	14:42:05	1083.519	19.633	2.633	16.745	2.745	29.84
12/23/2004	14:44:05	1085.519	19.604	2.604	16.716	2.716	29.842
12/23/2004	14:46:05	1087.519	19.604	2.604	16.73	2.73	29.84
12/23/2004	14:48:05	1089.519	19.604	2.604	16.716	2.716	29.84
12/23/2004	14:50:05	1091.519	19.604	2.604	16.716	2.716	29.842
12/23/2004	14:52:05	1093.519	20.18	3.18	17.275	3.275	23.668
12/23/2004	14:54:05	1095.519	20.195	3.195	17.247	3.247	9.443
12/23/2004	14:56:05	1097.519	19.532	2.532	16.63	2.63	22.848
12/23/2004	14:58:05	1099.519	19.518	2.518	16.616	2.616	22.848
12/23/2004	15:00:05	1101.519	20.18	3.18	17.232	3.232	23.668
12/23/2004	15:02:05	1103.519	19.503	2.503	16.601	2.601	22.848
12/23/2004	15:04:05	1105.519	20.152	3.152	17.232	3.232	23.668
12/23/2004	15:06:05	1107.519	19.489	2.489	16.573	2.573	22.848
12/23/2004	15:08:05	1109.519	20.152	3.152	17.204	3.204	23.668
12/23/2004	15:10:05	1111.519	19.474	2.474	16.573	2.573	22.848
12/23/2004	15:12:05	1113.519	19.46	2.46	16.558	2.558	22.848
12/23/2004	15:14:05	1115.519	20.123	3.123	17.189	3.189	23.668
12/23/2004	15:16:05	1117.519	20.108	3.108	17.16	3.16	23.668
12/23/2004	15:18:05	1119.519	19.431	2.431	16.53	2.53	22.848
12/23/2004	15:20:05	1121.519	20.065	3.065	17.132	3.132	23.668
12/23/2004	15:22:05	1123.519	20.08	3.08	17.146	3.146	23.668
12/23/2004	15:24:05	1125.519	20.065	3.065	17.132	3.132	23.668
12/23/2004	15:26:05	1127.519	20.065	3.065	17.117	3.117	23.668
12/23/2004	15:28:05	1129.519	20.051	3.051	17.117	3.117	23.668
12/23/2004	15:30:05	1131.519	20.065	3.065	17.117	3.117	23.668
12/23/2004	15:32:05	1133.519	20.051	3.051	17.117	3.117	23.668
12/23/2004	15:34:05	1135.519	20.036	3.036	17.103	3.103	23.668
12/23/2004	15:36:05	1137.519	20.036	3.036	17.089	3.089	23.668
12/23/2004	15:38:05	1139.519	19.359	2.359	16.444	2.444	22.848
12/23/2004	15:40:05	1141.519	19.359	2.359	16.444	2.444	22.848
12/23/2004	15:42:05	1143.519	20.022	3.022	17.074	3.074	23.668
12/23/2004	15:44:05	1145.519	20.008	3.008	17.06	3.06	23.668
12/23/2004	15:46:05	1147.519	20.008	3.008	17.046	3.046	23.668
12/23/2004	15:48:05	1149.519	19.979	2.979	17.046	3.046	23.668
12/23/2004	15:50:05	1151.519	19.964	2.964	17.031	3.031	23.668
12/23/2004	15:52:05	1153.519	19.33	2.33	16.415	2.415	22.848
12/23/2004	15:54:05	1155.519	19.979	2.979	17.046	3.046	23.668
12/23/2004	15:56:05	1157.519	19.979	2.979	17.031	3.031	23.668
12/23/2004	15:58:05	1159.519	19.301	2.301	16.386	2.386	22.848
12/23/2004	16:00:05	1161.519	19.95	2.95	17.003	3.003	23.668



12/23/2004	16:02:05	1163.519	19.964	2.964	17.017	3.017	23.668
12/23/2004	16:04:05	1165.519	19.287	2.287	16.372	2.372	22.848
12/23/2004	16:06:05	1167.519	19.273	2.273	16.358	2.358	22.848
12/23/2004	16:08:05	1169.519	19.273	2.273	16.358	2.358	22.848
12/23/2004	16:10:05	1171.519	19.935	2.935	16.988	2.988	23.668
12/23/2004	16:12:05	1173.519	19.273	2.273	16.343	2.343	22.848
12/23/2004	16:14:05	1175.519	19.258	2.258	16.343	2.343	22.848
12/23/2004	16:16:05	1177.519	19.244	2.244	16.329	2.329	22.848
12/23/2004	16:18:05	1179.519	19.907	2.907	16.96	2.96	23.668
12/23/2004	16:20:05	1181.519	19.907	2.907	16.945	2.945	23.668
12/23/2004	16:22:05	1183.519	19.215	2.215	16.3	2.3	22.848
12/23/2004	16:24:05	1185.519	19.907	2.907	16.945	2.945	23.668
12/23/2004	16:26:05	1187.519	19.878	2.878	16.945	2.945	23.668
12/23/2004	16:28:05	1189.519	19.2	2.2	16.286	2.286	22.848
12/23/2004	16:30:05	1191.519	19.2	2.2	16.272	2.272	22.848
12/23/2004	16:32:05	1193.519	19.878	2.878	16.917	2.917	23.668
12/23/2004	16:34:05	1195.519	19.82	2.82	16.902	2.902	23.668
12/23/2004	16:36:05	1197.519	19.863	2.863	16.902	2.902	23.668
12/23/2004	16:38:05	1199.519	19.172	2.172	16.257	2.257	22.848
12/23/2004	16:40:05	1201.519	19.172	2.172	16.243	2.243	22.848
12/23/2004	16:42:05	1203.519	19.172	2.172	16.243	2.243	22.848
12/23/2004	16:44:05	1205.519	19.157	2.157	16.243	2.243	22.848
12/23/2004	16:46:05	1207.519	19.157	2.157	16.229	2.229	22.848
12/23/2004	16:48:05	1209.519	19.143	2.143	16.243	2.243	22.848
12/23/2004	16:50:05	1211.519	19.82	2.82	16.874	2.874	23.668
12/23/2004	16:52:05	1213.519	19.777	2.777	16.859	2.859	23.668
12/23/2004	16:54:05	1215.519	19.791	2.791	16.874	2.874	23.668
12/23/2004	16:56:05	1217.519	19.128	2.128	16.214	2.214	22.848
12/23/2004	16:58:05	1219.519	19.791	2.791	16.859	2.859	23.668
12/23/2004	17:00:05	1221.519	19.128	2.128	16.2	2.2	22.848
12/23/2004	17:02:05	1223.519	19.114	2.114	16.2	2.2	22.848
12/23/2004	17:04:05	1225.519	19.777	2.777	16.816	2.816	23.668
12/23/2004	17:06:05	1227.519	19.763	2.763	16.816	2.816	23.668
12/23/2004	17:08:05	1229.519	19.777	2.777	16.816	2.816	23.668
12/23/2004	17:10:05	1231.519	19.748	2.748	16.802	2.802	23.668
12/23/2004	17:12:05	1233.519	19.748	2.748	16.802	2.802	23.668
12/23/2004	17:14:05	1235.519	19.085	2.085	16.157	2.157	22.848
12/23/2004	17:16:05	1237.519	19.071	2.071	16.157	2.157	22.848
12/23/2004	17:18:05	1239.519	19.085	2.085	16.157	2.157	22.848
12/23/2004	17:20:05	1241.519	19.734	2.734	16.788	2.788	23.668
12/23/2004	17:22:05	1243.519	19.748	2.748	16.788	2.788	23.668
12/23/2004	17:24:05	1245.519	19.071	2.071	16.157	2.157	22.848
12/23/2004	17:26:05	1247.519	19.071	2.071	16.143	2.143	22.848
12/23/2004	17:28:05	1249.519	19.719	2.719	16.788	2.788	23.668
12/23/2004	17:30:05	1251.519	19.071	2.071	16.143	2.143	22.848
12/23/2004	17:32:05	1253.519	19.056	2.056	16.128	2.128	22.848
12/23/2004	17:34:05	1255.519	19.042	2.042	16.128	2.128	22.848
12/23/2004	17:36:05	1257.519	19.719	2.719	16.773	2.773	23.668
12/23/2004	17:38:05	1259.519	19.042	2.042	16.128	2.128	22.848
12/23/2004	17:40:05	1261.519	19.042	2.042	16.128	2.128	22.848
12/23/2004	17:42:05	1263.519	19.719	2.719	16.759	2.759	23.668
12/23/2004	17:44:05	1265.519	19.676	2.676	16.745	2.745	23.668

12/23/2004	17:46:05	1267.519	19.69	2.69	16.745	2.745	23.668
12/23/2004	17:48:05	1269.519	19.676	2.676	16.745	2.745	23.668
12/23/2004	17:50:05	1271.519	19.028	2.028	16.114	2.114	22.848
12/23/2004	17:52:05	1273.519	19.69	2.69	16.745	2.745	23.668
12/23/2004	17:54:05	1275.519	19.705	2.705	16.745	2.745	23.668
12/23/2004	17:56:05	1277.519	19.028	2.028	16.1	2.1	22.848
12/23/2004	17:58:05	1279.519	19.69	2.69	16.759	2.759	23.668
12/23/2004	18:00:05	1281.519	19.69	2.69	16.759	2.759	23.668
12/23/2004	18:02:05	1283.519	19.69	2.69	16.745	2.745	23.668
12/23/2004	18:04:05	1285.519	19.013	2.013	16.114	2.114	22.848
12/23/2004	18:06:05	1287.519	19.647	2.647	16.73	2.73	23.668
12/23/2004	18:08:05	1289.519	19.676	2.676	16.716	2.716	23.668
12/23/2004	18:10:05	1291.519	19.662	2.662	16.716	2.716	23.668
12/23/2004	18:12:05	1293.519	19.647	2.647	16.716	2.716	23.668
12/23/2004	18:14:05	1295.519	18.999	1.999	16.085	2.085	22.848
12/23/2004	18:16:05	1297.519	18.999	1.999	16.085	2.085	22.848
12/23/2004	18:18:05	1299.519	19.647	2.647	16.716	2.716	23.668
12/23/2004	18:20:05	1301.519	18.984	1.984	16.071	2.071	22.848
12/23/2004	18:22:05	1303.519	19.662	2.662	16.702	2.702	23.668
12/23/2004	18:24:05	1305.519	19.633	2.633	16.687	2.687	23.668
12/23/2004	18:26:05	1307.519	19.633	2.633	16.687	2.687	23.668
12/23/2004	18:28:05	1309.519	19.647	2.647	16.702	2.702	23.668
12/23/2004	18:30:05	1311.519	18.97	1.97	16.071	2.071	22.848
12/23/2004	18:32:05	1313.519	19.633	2.633	16.702	2.702	23.668
12/23/2004	18:34:05	1315.519	19.633	2.633	16.702	2.702	23.668
12/23/2004	18:36:05	1317.519	19.647	2.647	16.702	2.702	23.668
12/23/2004	18:38:05	1319.519	19.647	2.647	16.702	2.702	23.668
12/23/2004	18:40:05	1321.519	19.633	2.633	16.702	2.702	23.668
12/23/2004	18:42:05	1323.519	18.984	1.984	16.085	2.085	22.848
12/23/2004	18:44:05	1325.519	19.647	2.647	16.702	2.702	23.668
12/23/2004	18:46:05	1327.519	19.662	2.662	16.716	2.716	23.668
12/23/2004	18:48:05	1329.519	19.647	2.647	16.702	2.702	23.668
12/23/2004	18:50:05	1331.519	18.97	1.97	16.071	2.071	22.848
12/23/2004	18:52:05	1333.519	18.97	1.97	16.071	2.071	22.848
12/23/2004	18:54:05	1335.519	19.633	2.633	16.687	2.687	23.668
12/23/2004	18:56:05	1337.519	18.955	1.955	16.057	2.057	22.848
12/23/2004	18:58:05	1339.519	19.604	2.604	16.687	2.687	23.668
12/23/2004	19:00:05	1341.519	18.955	1.955	16.057	2.057	22.848
12/23/2004	19:02:05	1343.519	19.618	2.618	16.687	2.687	23.668
12/23/2004	19:04:05	1345.519	19.633	2.633	16.687	2.687	23.668
12/23/2004	19:06:05	1347.519	19.618	2.618	16.687	2.687	23.668
12/23/2004	19:08:05	1349.519	19.633	2.633	16.687	2.687	23.668
12/23/2004	19:10:05	1351.519	19.604	2.604	16.687	2.687	23.668
12/23/2004	19:12:05	1353.519	19.618	2.618	16.687	2.687	23.668
12/23/2004	19:14:05	1355.519	19.618	2.618	16.673	2.673	23.668
12/23/2004	19:16:05	1357.519	19.618	2.618	16.687	2.687	23.668
12/23/2004	19:18:05	1359.519	18.97	1.97	16.057	2.057	22.848
12/23/2004	19:20:05	1361.519	19.633	2.633	16.702	2.702	23.668
12/23/2004	19:22:05	1363.519	19.633	2.633	16.687	2.687	23.668
12/23/2004	19:24:05	1365.519	19.633	2.633	16.702	2.702	23.668
12/23/2004	19:26:05	1367.519	19.647	2.647	16.702	2.702	23.668
12/23/2004	19:28:05	1369.519	19.633	2.633	16.687	2.687	23.668

12/23/2004	19:30:05	1371.519	19.633	2.633	16.702	2.702	23.668
12/23/2004	19:32:05	1373.519	19.633	2.633	16.702	2.702	23.668
12/23/2004	19:34:05	1375.519	18.97	1.97	16.071	2.071	22.848
12/23/2004	19:36:05	1377.519	19.647	2.647	16.702	2.702	23.668
12/23/2004	19:38:05	1379.519	19.647	2.647	16.716	2.716	23.668
12/23/2004	19:40:05	1381.519	19.633	2.633	16.702	2.702	23.668
12/23/2004	19:42:05	1383.519	19.633	2.633	16.687	2.687	23.668
12/23/2004	19:44:05	1385.519	18.97	1.97	16.057	2.057	22.848
12/23/2004	19:46:05	1387.519	19.633	2.633	16.702	2.702	23.668
12/23/2004	19:48:05	1389.519	19.647	2.647	16.716	2.716	23.668
12/23/2004	19:50:05	1391.519	19.647	2.647	16.716	2.716	23.668
12/23/2004	19:52:05	1393.519	19.647	2.647	16.73	2.73	23.668
12/23/2004	19:54:05	1395.519	19.662	2.662	16.73	2.73	23.668
12/23/2004	19:56:05	1397.519	19.662	2.662	16.73	2.73	23.668
12/23/2004	19:58:05	1399.519	19.662	2.662	16.745	2.745	23.668
12/23/2004	20:00:05	1401.519	19.676	2.676	16.745	2.745	23.668
12/23/2004	20:02:05	1403.519	19.676	2.676	16.745	2.745	23.668
12/23/2004	20:04:05	1405.519	19.69	2.69	16.745	2.745	23.668
12/23/2004	20:06:05	1407.519	19.676	2.676	16.745	2.745	23.668
12/23/2004	20:08:05	1409.519	19.676	2.676	16.745	2.745	23.668
12/23/2004	20:10:05	1411.519	19.676	2.676	16.759	2.759	23.668
12/23/2004	20:12:05	1413.519	19.69	2.69	16.759	2.759	23.668
12/23/2004	20:14:05	1415.519	19.056	2.056	16.171	2.171	22.848
12/23/2004	20:16:05	1417.519	19.719	2.719	16.788	2.788	23.668
12/23/2004	20:18:05	1419.519	19.705	2.705	16.802	2.802	23.668
12/23/2004	20:20:05	1421.519	19.719	2.719	16.816	2.816	23.668
12/23/2004	20:22:05	1423.519	19.705	2.705	16.788	2.788	23.668
12/23/2004	20:24:05	1425.519	19.705	2.705	16.802	2.802	23.668
12/23/2004	20:26:05	1427.519	19.705	2.705	16.788	2.788	23.668
12/23/2004	20:28:05	1429.519	19.719	2.719	16.802	2.802	23.668
12/23/2004	20:30:05	1431.519	19.042	2.042	16.171	2.171	22.848
12/23/2004	20:32:05	1433.519	19.719	2.719	16.802	2.802	23.668
12/23/2004	20:34:05	1435.519	19.719	2.719	16.802	2.802	23.668
12/23/2004	20:36:05	1437.519	19.734	2.734	16.816	2.816	23.668
12/23/2004	20:38:05	1439.519	19.734	2.734	16.816	2.816	23.668
12/23/2004	20:40:05	1441.519	19.071	2.071	16.2	2.2	22.848
12/23/2004	20:42:05	1443.519	19.748	2.748	16.816	2.816	23.668
12/23/2004	20:44:05	1445.519	19.734	2.734	16.831	2.831	23.668
12/23/2004	20:46:05	1447.519	19.748	2.748	16.831	2.831	23.668
12/23/2004	20:48:05	1449.519	19.734	2.734	16.816	2.816	23.668
12/23/2004	20:50:05	1451.519	19.071	2.071	16.186	2.186	22.848
12/23/2004	20:52:05	1453.519	19.748	2.748	16.831	2.831	23.668
12/23/2004	20:54:05	1455.519	19.748	2.748	16.859	2.859	23.668
12/23/2004	20:56:05	1457.519	19.085	2.085	16.229	2.229	22.848
12/23/2004	20:58:05	1459.519	19.763	2.763	16.874	2.874	23.668
12/23/2004	21:00:05	1461.519	19.763	2.763	16.888	2.888	23.668
12/23/2004	21:02:05	1463.519	19.777	2.777	16.874	2.874	23.668
12/23/2004	21:04:05	1465.519	19.763	2.763	16.874	2.874	23.668
12/23/2004	21:06:05	1467.519	19.763	2.763	16.888	2.888	23.668
12/23/2004	21:08:05	1469.519	19.1	2.1	16.229	2.229	22.848
12/23/2004	21:10:05	1471.519	19.791	2.791	16.902	2.902	23.668
12/23/2004	21:12:05	1473.519	19.777	2.777	16.888	2.888	23.668

12/23/2004	21:14:05	1475.519	19.763	2.763	16.888	2.888	23.668
12/23/2004	21:16:05	1477.519	19.777	2.777	16.874	2.874	23.668
12/23/2004	21:18:05	1479.519	19.777	2.777	16.874	2.874	23.668
12/23/2004	21:20:05	1481.519	19.777	2.777	16.888	2.888	23.668
12/23/2004	21:22:05	1483.519	19.791	2.791	16.888	2.888	23.668
12/23/2004	21:24:05	1485.519	19.791	2.791	16.888	2.888	23.668
12/23/2004	21:26:05	1487.519	19.806	2.806	16.917	2.917	23.668
12/23/2004	21:28:05	1489.519	19.82	2.82	16.931	2.931	23.668
12/23/2004	21:30:05	1491.519	19.806	2.806	16.902	2.902	23.668
12/23/2004	21:32:05	1493.519	19.791	2.791	16.888	2.888	23.668
12/23/2004	21:34:05	1495.519	19.791	2.791	16.888	2.888	23.668
12/23/2004	21:36:05	1497.519	19.791	2.791	16.888	2.888	23.668
12/23/2004	21:38:05	1499.519	19.114	2.114	16.243	2.243	22.848
12/23/2004	21:40:05	1501.519	19.791	2.791	16.902	2.902	23.668
12/23/2004	21:42:05	1503.519	19.791	2.791	16.902	2.902	23.668
12/23/2004	21:44:05	1505.519	19.128	2.128	16.257	2.257	22.848
12/23/2004	21:46:05	1507.519	19.777	2.777	16.874	2.874	23.668
12/23/2004	21:48:05	1509.519	19.763	2.763	16.874	2.874	23.668
12/23/2004	21:50:05	1511.519	19.777	2.777	16.874	2.874	23.668
12/23/2004	21:52:05	1513.519	19.791	2.791	16.902	2.902	23.668
12/23/2004	21:54:05	1515.519	19.806	2.806	16.888	2.888	23.668
12/23/2004	21:56:05	1517.519	19.143	2.143	16.272	2.272	22.848
12/23/2004	21:58:05	1519.519	19.806	2.806	16.917	2.917	23.668
12/23/2004	22:00:05	1521.519	19.806	2.806	16.917	2.917	23.668
12/23/2004	22:02:05	1523.519	19.143	2.143	16.286	2.286	22.848
12/23/2004	22:04:05	1525.519	19.806	2.806	16.931	2.931	23.668
12/23/2004	22:06:05	1527.519	19.157	2.157	16.286	2.286	22.848
12/23/2004	22:08:05	1529.519	19.82	2.82	16.945	2.945	23.668
12/23/2004	22:10:05	1531.519	19.82	2.82	16.945	2.945	23.668
12/23/2004	22:12:05	1533.519	19.82	2.82	16.945	2.945	23.668
12/23/2004	22:14:05	1535.519	19.806	2.806	16.931	2.931	23.668
12/23/2004	22:16:05	1537.519	19.835	2.835	16.945	2.945	23.668
12/23/2004	22:18:05	1539.519	19.835	2.835	16.945	2.945	23.668
12/23/2004	22:20:05	1541.519	19.82	2.82	16.931	2.931	23.668
12/23/2004	22:22:05	1543.519	19.806	2.806	16.917	2.917	23.668
12/23/2004	22:24:05	1545.519	19.806	2.806	16.917	2.917	23.668
12/23/2004	22:26:05	1547.519	19.806	2.806	16.931	2.931	23.668
12/23/2004	22:28:05	1549.519	19.82	2.82	16.931	2.931	23.668
12/23/2004	22:30:05	1551.519	19.835	2.835	16.945	2.945	23.668
12/23/2004	22:32:05	1553.519	19.835	2.835	16.945	2.945	23.668
12/23/2004	22:34:05	1555.519	19.82	2.82	16.945	2.945	23.668
12/23/2004	22:36:05	1557.519	19.835	2.835	16.945	2.945	23.668
12/23/2004	22:38:05	1559.519	19.82	2.82	16.931	2.931	23.668
12/23/2004	22:40:05	1561.519	19.82	2.82	16.945	2.945	23.668
12/23/2004	22:42:05	1563.519	19.82	2.82	16.931	2.931	23.668
12/23/2004	22:44:05	1565.519	19.835	2.835	16.945	2.945	23.668
12/23/2004	22:46:05	1567.519	19.835	2.835	16.945	2.945	23.668
12/23/2004	22:48:05	1569.519	19.82	2.82	16.931	2.931	23.668
12/23/2004	22:50:05	1571.519	19.835	2.835	16.945	2.945	23.668
12/23/2004	22:52:05	1573.519	19.863	2.863	16.96	2.96	23.668
12/23/2004	22:54:05	1575.519	19.878	2.878	16.974	2.974	23.668
12/23/2004	22:56:05	1577.519	19.878	2.878	16.974	2.974	23.668

12/23/2004	22:58:05	1579.519	19.878	2.878	16.974	2.974	23.668
12/23/2004	23:00:05	1581.519	19.878	2.878	16.974	2.974	23.668
12/23/2004	23:02:05	1583.519	19.878	2.878	16.974	2.974	23.668
12/23/2004	23:04:05	1585.519	19.878	2.878	16.988	2.988	23.668
12/23/2004	23:06:05	1587.519	19.878	2.878	16.988	2.988	23.668
12/23/2004	23:08:05	1589.519	19.878	2.878	16.974	2.974	23.668
12/23/2004	23:10:05	1591.519	19.863	2.863	16.974	2.974	23.668
12/23/2004	23:12:05	1593.519	19.878	2.878	16.974	2.974	23.668
12/23/2004	23:14:05	1595.519	19.863	2.863	16.988	2.988	23.668
12/23/2004	23:16:05	1597.519	19.835	2.835	16.96	2.96	23.668
12/23/2004	23:18:05	1599.519	19.892	2.892	16.974	2.974	23.668
12/23/2004	23:20:05	1601.519	19.863	2.863	16.96	2.96	23.668
12/23/2004	23:22:05	1603.519	19.878	2.878	16.974	2.974	23.668
12/23/2004	23:24:05	1605.519	19.835	2.835	16.945	2.945	23.668
12/23/2004	23:26:05	1607.519	19.863	2.863	16.945	2.945	23.668
12/23/2004	23:28:05	1609.519	19.82	2.82	16.945	2.945	23.668
12/23/2004	23:30:05	1611.519	19.806	2.806	16.931	2.931	23.668
12/23/2004	23:32:05	1613.519	19.82	2.82	16.917	2.917	23.668
12/23/2004	23:34:05	1615.519	19.806	2.806	16.917	2.917	23.668
12/23/2004	23:36:05	1617.519	19.806	2.806	16.888	2.888	23.668
12/23/2004	23:38:05	1619.519	19.791	2.791	16.874	2.874	23.668
12/23/2004	23:40:05	1621.519	19.777	2.777	16.888	2.888	23.668
12/23/2004	23:42:05	1623.519	19.791	2.791	16.888	2.888	23.668
12/23/2004	23:44:05	1625.519	19.777	2.777	16.888	2.888	23.668
12/23/2004	23:46:05	1627.519	19.777	2.777	16.888	2.888	23.668
12/23/2004	23:48:05	1629.519	19.763	2.763	16.888	2.888	23.668
12/23/2004	23:50:05	1631.519	19.763	2.763	16.874	2.874	23.668
12/23/2004	23:52:05	1633.519	19.763	2.763	16.874	2.874	23.668
12/23/2004	23:54:05	1635.519	19.763	2.763	16.874	2.874	23.668
12/23/2004	23:56:05	1637.519	19.763	2.763	16.874	2.874	23.668
12/23/2004	23:58:05	1639.519	19.763	2.763	16.874	2.874	23.668
12/24/2004	0:00:05	1641.519	19.763	2.763	16.859	2.859	23.668
12/24/2004	0:02:05	1643.519	19.763	2.763	16.859	2.859	23.668
12/24/2004	0:04:05	1645.519	19.748	2.748	16.859	2.859	23.668
12/24/2004	0:06:05	1647.519	19.748	2.748	16.831	2.831	23.668
12/24/2004	0:08:05	1649.519	19.763	2.763	16.831	2.831	23.668
12/24/2004	0:10:05	1651.519	19.734	2.734	16.831	2.831	23.668
12/24/2004	0:12:05	1653.519	19.734	2.734	16.859	2.859	23.668
12/24/2004	0:14:05	1655.519	19.734	2.734	16.816	2.816	23.668
12/24/2004	0:16:05	1657.519	19.748	2.748	16.831	2.831	23.668
12/24/2004	0:18:05	1659.519	19.734	2.734	16.816	2.816	23.668
12/24/2004	0:20:05	1661.519	19.719	2.719	16.816	2.816	23.668
12/24/2004	0:22:05	1663.519	19.719	2.719	16.802	2.802	23.668
12/24/2004	0:24:05	1665.519	19.719	2.719	16.816	2.816	23.668
12/24/2004	0:26:05	1667.519	19.705	2.705	16.802	2.802	23.668
12/24/2004	0:28:05	1669.519	19.705	2.705	16.788	2.788	23.668
12/24/2004	0:30:05	1671.519	19.705	2.705	16.788	2.788	23.668
12/24/2004	0:32:05	1673.519	19.719	2.719	16.788	2.788	23.668
12/24/2004	0:34:05	1675.519	19.69	2.69	16.788	2.788	23.668
12/24/2004	0:36:05	1677.519	19.69	2.69	16.773	2.773	23.668
12/24/2004	0:38:05	1679.519	19.676	2.676	16.788	2.788	23.668
12/24/2004	0:40:05	1681.519	19.69	2.69	16.773	2.773	23.668

12/24/2004	0:42:05	1683.519	19.676	2.676	16.773	2.773	23.668
12/24/2004	0:44:05	1685.519	19.69	2.69	16.759	2.759	23.668
12/24/2004	0:46:05	1687.519	19.662	2.662	16.759	2.759	23.668
12/24/2004	0:48:05	1689.519	19.69	2.69	16.759	2.759	23.668
12/24/2004	0:50:05	1691.519	19.662	2.662	16.745	2.745	23.668
12/24/2004	0:52:05	1693.519	19.647	2.647	16.73	2.73	23.668
12/24/2004	0:54:05	1695.519	19.633	2.633	16.716	2.716	23.668
12/24/2004	0:56:05	1697.519	19.604	2.604	16.716	2.716	23.668
12/24/2004	0:58:05	1699.519	19.662	2.662	16.716	2.716	23.668
12/24/2004	1:00:05	1701.519	19.633	2.633	16.73	2.73	23.668
12/24/2004	1:02:05	1703.519	19.618	2.618	16.702	2.702	23.668
12/24/2004	1:04:05	1705.519	19.633	2.633	16.702	2.702	23.668
12/24/2004	1:06:05	1707.519	19.618	2.618	16.759	2.759	23.668
12/24/2004	1:08:05	1709.519	19.647	2.647	16.702	2.702	23.668
12/24/2004	1:10:05	1711.519	19.633	2.633	16.687	2.687	23.668
12/24/2004	1:12:05	1713.519	19.604	2.604	16.702	2.702	23.668
12/24/2004	1:14:05	1715.519	19.604	2.604	16.673	2.673	23.668
12/24/2004	1:16:05	1717.519	19.59	2.59	16.687	2.687	23.668
12/24/2004	1:18:05	1719.519	19.59	2.59	16.687	2.687	23.668
12/24/2004	1:20:05	1721.519	19.59	2.59	16.687	2.687	23.668
12/24/2004	1:22:05	1723.519	19.604	2.604	16.687	2.687	23.668
12/24/2004	1:24:05	1725.519	19.604	2.604	16.687	2.687	23.668
12/24/2004	1:26:05	1727.519	19.59	2.59	16.687	2.687	23.668
12/24/2004	1:28:05	1729.519	19.604	2.604	16.673	2.673	23.668
12/24/2004	1:30:05	1731.519	19.575	2.575	16.673	2.673	23.668
12/24/2004	1:32:05	1733.519	19.59	2.59	16.673	2.673	23.668
12/24/2004	1:34:05	1735.519	19.59	2.59	16.644	2.644	23.668
12/24/2004	1:36:05	1737.519	19.561	2.561	16.63	2.63	23.668
12/24/2004	1:38:05	1739.519	19.561	2.561	16.63	2.63	23.668
12/24/2004	1:40:05	1741.519	19.546	2.546	16.63	2.63	23.668
12/24/2004	1:42:05	1743.519	19.546	2.546	16.63	2.63	23.668
12/24/2004	1:44:05	1745.519	19.532	2.532	16.616	2.616	23.668
12/24/2004	1:46:05	1747.519	19.532	2.532	16.601	2.601	23.668
12/24/2004	1:48:05	1749.519	19.489	2.489	16.601	2.601	23.668
12/24/2004	1:50:05	1751.519	19.503	2.503	16.616	2.616	23.668
12/24/2004	1:52:05	1753.519	19.503	2.503	16.587	2.587	23.668
12/24/2004	1:54:05	1755.519	19.503	2.503	16.573	2.573	23.668
12/24/2004	1:56:05	1757.519	19.503	2.503	16.558	2.558	23.668
12/24/2004	1:58:05	1759.519	19.474	2.474	16.53	2.53	23.668
12/24/2004	2:00:05	1761.519	19.46	2.46	16.544	2.544	23.668
12/24/2004	2:02:05	1763.519	19.474	2.474	16.53	2.53	23.668
12/24/2004	2:04:05	1765.519	19.474	2.474	16.53	2.53	23.668
12/24/2004	2:06:05	1767.519	19.46	2.46	16.53	2.53	23.668
12/24/2004	2:08:05	1769.519	19.445	2.445	16.515	2.515	23.668
12/24/2004	2:10:05	1771.519	19.431	2.431	16.501	2.501	23.668
12/24/2004	2:12:05	1773.519	19.431	2.431	16.487	2.487	23.668
12/24/2004	2:14:05	1775.519	19.431	2.431	16.472	2.472	23.668
12/24/2004	2:16:05	1777.519	19.373	2.373	16.472	2.472	23.668
12/24/2004	2:18:05	1779.519	19.388	2.388	16.444	2.444	23.668
12/24/2004	2:20:05	1781.519	19.373	2.373	16.444	2.444	23.668
12/24/2004	2:22:05	1783.519	19.359	2.359	16.429	2.429	23.668
12/24/2004	2:24:05	1785.519	19.345	2.345	16.415	2.415	23.668

12/24/2004	2:26:05	1787.519	19.345	2.345	16.386	2.386	23.668
12/24/2004	2:28:05	1789.519	19.33	2.33	16.372	2.372	23.668
12/24/2004	2:30:05	1791.519	19.316	2.316	16.358	2.358	23.668
12/24/2004	2:32:05	1793.519	19.316	2.316	16.343	2.343	23.668
12/24/2004	2:34:05	1795.519	19.301	2.301	16.358	2.358	23.668
12/24/2004	2:36:05	1797.519	19.301	2.301	16.358	2.358	23.668
12/24/2004	2:38:05	1799.519	19.287	2.287	16.343	2.343	23.668
12/24/2004	2:40:05	1801.519	19.258	2.258	16.329	2.329	23.668
12/24/2004	2:42:05	1803.519	19.258	2.258	16.3	2.3	23.668
12/24/2004	2:44:05	1805.519	19.258	2.258	16.3	2.3	23.668
12/24/2004	2:46:05	1807.519	19.244	2.244	16.286	2.286	23.668
12/24/2004	2:48:05	1809.519	19.244	2.244	16.286	2.286	23.668
12/24/2004	2:50:05	1811.519	19.229	2.229	16.272	2.272	23.668
12/24/2004	2:52:05	1813.519	19.229	2.229	16.272	2.272	23.668
12/24/2004	2:54:05	1815.519	19.229	2.229	16.272	2.272	23.668
12/24/2004	2:56:05	1817.519	19.215	2.215	16.257	2.257	23.668
12/24/2004	2:58:05	1819.519	19.215	2.215	16.243	2.243	23.668
12/24/2004	3:00:05	1821.519	19.2	2.2	16.243	2.243	23.668
12/24/2004	3:02:05	1823.519	19.186	2.186	16.229	2.229	23.668
12/24/2004	3:04:05	1825.519	19.157	2.157	16.186	2.186	23.668
12/24/2004	3:06:05	1827.519	19.157	2.157	16.214	2.214	23.668
12/24/2004	3:08:05	1829.519	19.157	2.157	16.186	2.186	23.668
12/24/2004	3:10:05	1831.519	19.143	2.143	16.171	2.171	23.668
12/24/2004	3:12:05	1833.519	19.128	2.128	16.186	2.186	23.668
12/24/2004	3:14:05	1835.519	19.128	2.128	16.157	2.157	23.668
12/24/2004	3:16:05	1837.519	19.114	2.114	16.157	2.157	23.668
12/24/2004	3:18:05	1839.519	19.1	2.1	16.114	2.114	23.668
12/24/2004	3:20:05	1841.519	19.1	2.1	16.128	2.128	23.668
12/24/2004	3:22:05	1843.519	19.1	2.1	16.128	2.128	23.668
12/24/2004	3:24:05	1845.519	19.056	2.056	16.1	2.1	23.668
12/24/2004	3:26:05	1847.519	19.071	2.071	16.1	2.1	23.668
12/24/2004	3:28:05	1849.519	19.071	2.071	16.085	2.085	23.668
12/24/2004	3:30:05	1851.519	19.056	2.056	16.071	2.071	23.668
12/24/2004	3:32:05	1853.519	19.028	2.028	16.057	2.057	23.668
12/24/2004	3:34:05	1855.519	19.028	2.028	16.042	2.042	23.668
12/24/2004	3:36:05	1857.519	18.999	1.999	16.042	2.042	23.668
12/24/2004	3:38:05	1859.519	18.984	1.984	16.028	2.028	23.668
12/24/2004	3:40:05	1861.519	18.984	1.984	16.014	2.014	23.668
12/24/2004	3:42:05	1863.519	18.984	1.984	16.014	2.014	23.668
12/24/2004	3:44:05	1865.519	18.941	1.941	15.985	1.985	23.668
12/24/2004	3:46:05	1867.519	18.97	1.97	15.985	1.985	23.668
12/24/2004	3:48:05	1869.519	18.941	1.941	15.985	1.985	23.668
12/24/2004	3:50:05	1871.519	18.941	1.941	15.942	1.942	23.668
12/24/2004	3:52:05	1873.519	18.898	1.898	15.942	1.942	23.668
12/24/2004	3:54:05	1875.519	18.912	1.912	15.928	1.928	23.668
12/24/2004	3:56:05	1877.519	18.898	1.898	15.928	1.928	23.668
12/24/2004	3:58:05	1879.519	18.883	1.883	15.899	1.899	23.668
12/24/2004	4:00:05	1881.519	18.898	1.898	15.899	1.899	23.668
12/24/2004	4:02:05	1883.519	18.869	1.869	15.885	1.885	23.668
12/24/2004	4:04:05	1885.519	18.855	1.855	15.885	1.885	23.668
12/24/2004	4:06:05	1887.519	18.855	1.855	15.87	1.87	23.668
12/24/2004	4:08:05	1889.519	18.826	1.826	15.842	1.842	23.668

12/24/2004	4:10:05	1891.519	18.826	1.826	15.856	1.856	23.668
12/24/2004	4:12:05	1893.519	18.826	1.826	15.842	1.842	23.668
12/24/2004	4:14:05	1895.519	18.826	1.826	15.842	1.842	23.668
12/24/2004	4:16:05	1897.519	18.855	1.855	15.856	1.856	23.668
12/24/2004	4:18:05	1899.519	18.826	1.826	15.842	1.842	23.668
12/24/2004	4:20:05	1901.519	18.826	1.826	15.842	1.842	23.668
12/24/2004	4:22:05	1903.519	18.797	1.797	15.842	1.842	23.668
12/24/2004	4:24:05	1905.519	18.811	1.811	15.842	1.842	23.668
12/24/2004	4:26:05	1907.519	18.811	1.811	15.842	1.842	23.668
12/24/2004	4:28:05	1909.519	18.811	1.811	15.842	1.842	23.668
12/24/2004	4:30:05	1911.519	18.811	1.811	15.842	1.842	23.668
12/24/2004	4:32:05	1913.519	18.797	1.797	15.827	1.827	23.668
12/24/2004	4:34:05	1915.519	18.797	1.797	15.827	1.827	23.668
12/24/2004	4:36:05	1917.519	18.754	1.754	15.813	1.813	23.668
12/24/2004	4:38:05	1919.519	18.768	1.768	15.784	1.784	23.668
12/24/2004	4:40:05	1921.519	18.768	1.768	15.77	1.77	23.668
12/24/2004	4:42:05	1923.519	18.754	1.754	15.784	1.784	23.668
12/24/2004	4:44:05	1925.519	18.754	1.754	15.77	1.77	23.668
12/24/2004	4:46:05	1927.519	18.754	1.754	15.77	1.77	23.668
12/24/2004	4:48:05	1929.519	18.754	1.754	15.784	1.784	23.668
12/24/2004	4:50:05	1931.519	18.739	1.739	15.77	1.77	23.668
12/24/2004	4:52:05	1933.519	18.725	1.725	15.741	1.741	23.668
12/24/2004	4:54:05	1935.519	18.739	1.739	15.741	1.741	23.668
12/24/2004	4:56:05	1937.519	18.71	1.71	15.727	1.727	23.668
12/24/2004	4:58:05	1939.519	18.71	1.71	15.698	1.698	23.668
12/24/2004	5:00:05	1941.519	18.696	1.696	15.713	1.713	23.668
12/24/2004	5:02:05	1943.519	18.696	1.696	15.727	1.727	23.668
12/24/2004	5:04:05	1945.519	18.696	1.696	15.727	1.727	23.668
12/24/2004	5:06:05	1947.519	18.696	1.696	15.713	1.713	23.668
12/24/2004	5:08:05	1949.519	18.682	1.682	15.698	1.698	23.668
12/24/2004	5:10:05	1951.519	18.682	1.682	15.727	1.727	23.668
12/24/2004	5:12:05	1953.519	18.696	1.696	15.698	1.698	23.668
12/24/2004	5:14:05	1955.519	18.667	1.667	15.684	1.684	23.668
12/24/2004	5:16:05	1957.519	18.667	1.667	15.698	1.698	23.668
12/24/2004	5:18:05	1959.519	18.667	1.667	15.655	1.655	23.668
12/24/2004	5:20:05	1961.519	18.653	1.653	15.698	1.698	23.668
12/24/2004	5:22:05	1963.519	18.638	1.638	15.67	1.67	23.668
12/24/2004	5:24:05	1965.519	18.653	1.653	15.684	1.684	23.668
12/24/2004	5:26:05	1967.519	18.653	1.653	15.684	1.684	23.668
12/24/2004	5:28:05	1969.519	18.653	1.653	15.67	1.67	23.668
12/24/2004	5:30:05	1971.519	18.624	1.624	15.641	1.641	23.668
12/24/2004	5:32:05	1973.519	18.624	1.624	15.67	1.67	23.668
12/24/2004	5:34:05	1975.519	18.61	1.61	15.641	1.641	23.668
12/24/2004	5:36:05	1977.519	18.595	1.595	15.612	1.612	23.668
12/24/2004	5:38:05	1979.519	18.61	1.61	15.641	1.641	23.668
12/24/2004	5:40:05	1981.519	18.595	1.595	15.627	1.627	23.668
12/24/2004	5:42:05	1983.519	18.595	1.595	15.627	1.627	23.668
12/24/2004	5:44:05	1985.519	18.61	1.61	15.627	1.627	23.668
12/24/2004	5:46:05	1987.519	18.61	1.61	15.627	1.627	23.668
12/24/2004	5:48:05	1989.519	18.595	1.595	15.612	1.612	23.668
12/24/2004	5:50:05	1991.519	18.581	1.581	15.612	1.612	23.668
12/24/2004	5:52:05	1993.519	18.595	1.595	15.612	1.612	23.668



12/24/2004	5:54:05	1995.519	18.566	1.566	15.584	1.584	23.668
12/24/2004	5:56:05	1997.519	18.581	1.581	15.569	1.569	23.668
12/24/2004	5:58:05	1999.519	18.566	1.566	15.584	1.584	23.668
12/24/2004	6:00:05	2001.519	18.566	1.566	15.569	1.569	23.668
12/24/2004	6:02:05	2003.519	18.552	1.552	15.555	1.555	23.668
12/24/2004	6:04:05	2005.519	18.552	1.552	15.555	1.555	23.668
12/24/2004	6:06:05	2007.519	18.538	1.538	15.541	1.541	23.668
12/24/2004	6:08:05	2009.519	18.538	1.538	15.555	1.555	23.668
12/24/2004	6:10:05	2011.519	18.538	1.538	15.569	1.569	23.668
12/24/2004	6:12:05	2013.519	18.538	1.538	15.569	1.569	23.668
12/24/2004	6:14:05	2015.519	18.552	1.552	15.555	1.555	23.668
12/24/2004	6:16:05	2017.519	18.523	1.523	15.555	1.555	23.668
12/24/2004	6:18:05	2019.519	18.538	1.538	15.569	1.569	23.668
12/24/2004	6:20:05	2021.519	18.538	1.538	15.569	1.569	23.668
12/24/2004	6:22:05	2023.519	18.552	1.552	15.555	1.555	23.668
12/24/2004	6:24:05	2025.519	18.523	1.523	15.541	1.541	23.668
12/24/2004	6:26:05	2027.519	18.494	1.494	15.526	1.526	23.668
12/24/2004	6:28:05	2029.519	18.523	1.523	15.555	1.555	23.668
12/24/2004	6:30:05	2031.519	18.494	1.494	15.526	1.526	23.668
12/24/2004	6:32:05	2033.519	18.523	1.523	15.541	1.541	23.668
12/24/2004	6:34:05	2035.519	18.494	1.494	15.526	1.526	23.668
12/24/2004	6:36:05	2037.519	18.494	1.494	15.541	1.541	23.668
12/24/2004	6:38:05	2039.519	18.523	1.523	15.555	1.555	23.668
12/24/2004	6:40:05	2041.519	18.538	1.538	15.569	1.569	23.668
12/24/2004	6:42:05	2043.519	18.494	1.494	15.541	1.541	23.668
12/24/2004	6:44:05	2045.519	18.523	1.523	15.541	1.541	23.668
12/24/2004	6:46:05	2047.519	18.494	1.494	15.541	1.541	23.668
12/24/2004	6:48:05	2049.519	18.494	1.494	15.541	1.541	23.668
12/24/2004	6:50:05	2051.519	18.465	1.465	15.526	1.526	23.668
12/24/2004	6:52:05	2053.519	18.494	1.494	15.526	1.526	23.668
12/24/2004	6:54:05	2055.519	18.48	1.48	15.526	1.526	23.668
12/24/2004	6:56:05	2057.519	18.48	1.48	15.526	1.526	23.668
12/24/2004	6:58:05	2059.519	18.494	1.494	15.526	1.526	23.668
12/24/2004	7:00:05	2061.519	18.494	1.494	15.526	1.526	23.668
12/24/2004	7:02:05	2063.519	18.494	1.494	15.526	1.526	23.668
12/24/2004	7:04:05	2065.519	18.48	1.48	15.541	1.541	23.668
12/24/2004	7:06:05	2067.519	18.494	1.494	15.526	1.526	23.668
12/24/2004	7:08:05	2069.519	18.494	1.494	15.526	1.526	23.668
12/24/2004	7:10:05	2071.519	18.494	1.494	15.526	1.526	23.668
12/24/2004	7:12:05	2073.519	18.494	1.494	15.541	1.541	23.668
12/24/2004	7:14:05	2075.519	18.523	1.523	15.569	1.569	23.668
12/24/2004	7:16:05	2077.519	18.494	1.494	15.541	1.541	23.668
12/24/2004	7:18:05	2079.519	18.494	1.494	15.526	1.526	23.668
12/24/2004	7:20:05	2081.519	18.48	1.48	15.526	1.526	23.668
12/24/2004	7:22:05	2083.519	18.465	1.465	15.526	1.526	23.668
12/24/2004	7:24:05	2085.519	18.494	1.494	15.526	1.526	23.668
12/24/2004	7:26:05	2087.519	18.494	1.494	15.541	1.541	23.668
12/24/2004	7:28:05	2089.519	18.494	1.494	15.541	1.541	23.668
12/24/2004	7:30:05	2091.519	18.494	1.494	15.541	1.541	23.668
12/24/2004	7:32:05	2093.519	18.494	1.494	15.555	1.555	23.668
12/24/2004	7:34:05	2095.519	18.465	1.465	15.541	1.541	23.668
12/24/2004	7:36:05	2097.519	17.86	0.86	14.924	0.924	22.848

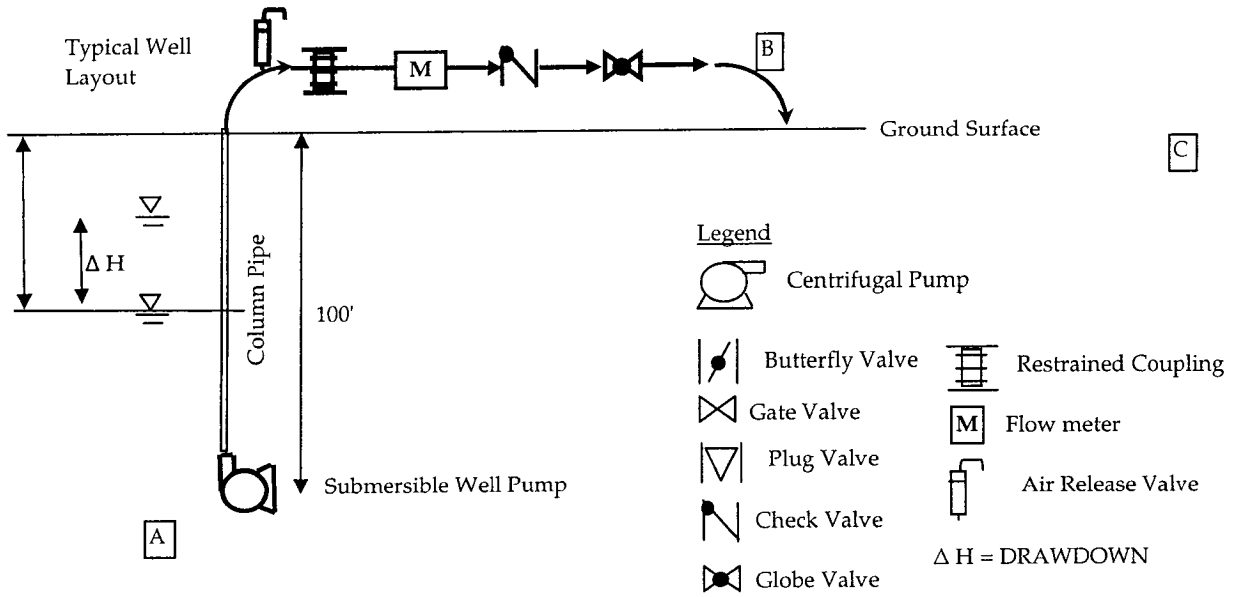

**KNOWN:**

- The following are the specified conditions of service for the Production well No. 15 pump:
  - Q = 500 gpm
  - TDH = 310 ft
  - Max. Motor HP = 60
  - Pump setting = 140 feet BGS (below ground surface)

**REQUIREMENTS:**

- Total Dynamic Head Calculation
- Selected Pump Head Design Calculation

**CALCULATIONS**

**A. Total Dynamic Head (TDH)**

TDH is specified in the Project Manual. The following is the design TDH for the new well pump:

Required TDH =	310 Feet
----------------	----------



Client:	Dare County Water Department	Job No.	17952-37350
Project:	North RO Facility Wellfield	Date Checked	3/7/2005
Detail:	Production Well No. 15 Hydraulics	Checked By	CDM

**B. Selected Pump Head Design Calculation**

- The County requested the design of the submersible well pump be based on 316L SS pumps as manufactured by Goulds.
- Selected Pump will be a Goulds Model 7TNLC. Please refer to attached pump information for the following calculations:

Design Q = 500 gpm  
 TDH = 310 feet

From Single Stage Performance Curve at 500 gpm, single stage head is 60 feet.

No. Stages Required = TDH Required/Head per stage

310 feet/60 feet/stage

5.17 Stages

**USE 6 Stages**

Actual TDH/stage = 6 stages x 60 feet/stage

**Actual TDH = 360 Feet**

**Motor Horsepower Required**

HP Required =  $\frac{Q \times TDH}{3960 \times \text{pump efficiency}}$

From Pump performance curve, pump efficiency at 500 gpm is approximately 80%

$\frac{500 \text{ gpm} \times 310 \text{ feet}}{3960 \times 0.80}$

HP Required = 48.9

**HP Installed = 60** <<<< OK. Installed HP greater than required.

**Discharge Pressure**

Static Water Level = 14 feet (BGS)

Drawdown = 21.5 feet at 500 gpm based on Step Drawdown test of the new well.

TDH = 310 feet

Discharge Pressure =  $\frac{TDH - \text{Drawdown} - \text{Static Water Level}}{2.31}$

=  $\frac{310 - 21.5 - 14}{2.31}$

**Discharge Pressure = 118.8 PSI** This exceeds the current average discharge pressure of the PW#10

# 316 Stainless Steel Submersible Turbine Pumps

5"-11" Diameter  
For 6" and larger wells

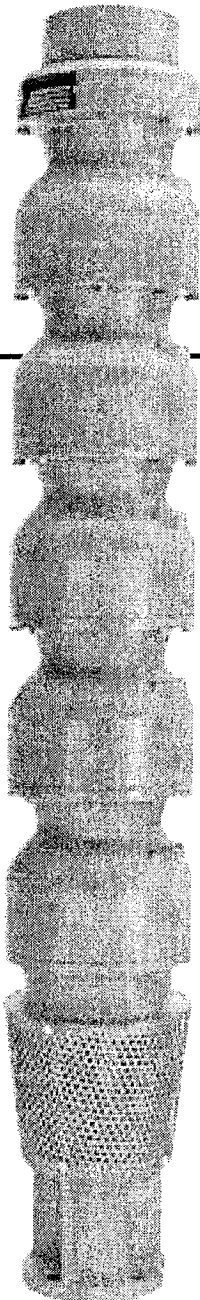

**SPECIFICATIONS – 3450 RPM**

Model	Max. PSI	Max. TDH	Max. Stage	Operating Range GPM	Best Efficiency Range	Horsepower Range	Discharge Connections	Minimum Well Size
5CNLC	460	1063	18	60 – 180	115	5 – 30	4"	6"
5CNHC	450	1040	17	60 – 200	140	5 – 50	4"	6"
5TNLC	475	1097	20	80 – 225	175	5 – 30	4"	6"
5TNHC	460	1063	20	150 – 300	240	5 – 50	4"	6"
6CNLC	455	1051	13	100 – 225	160	5 – 40	4"	8"
6CNHC	450	1040	13	150 – 300	225	10 – 50	4"	8"
7CNLC	425	982	8	275 – 430	350	10 – 75	4", 6"	8"
7CNHC	405	936	8	300 – 600	450	15 – 100	4", 6"	8"
7TNLC	412	952	8	300 – 650	550	10 – 75	4", 6"	8"
7TNHC	395	915	9	375 – 800	600	15 – 100	4", 6"	8"
9CNLC	495	1144	6	400 – 875	600	30 – 150	6"	10"
9CNHC	490	1132	6	550 – 1200	900	50 – 150	6"	10"
9TNLC	530	1224	7	700 – 1400	1050	40 – 150	6"	10"
9TNHC	462	1067	6	900 – 1700	1300	50 – 150	6"	10"
11CNLC	545	1259	4	500 – 1700	1200	75 – 150	6", 8"	12"

**FEATURES**

- **Discharge Adapter:** Several discharge sizes available with NPT or Flanged design in 316 SS.
- **Discharge Bearing:** Extra long sealed top bronze bearing insures positive shaft alignment and stabilization for extended life. Standard bronze bearings are of a superior quality Bismuth alloy to ensure tensile strength, yield strength, and percent-age elongation results.

- **Intermediate Bowl:** High efficiency design in cast 316 stainless steel.
- **Impellers:** Designed for maximum efficiency with wide range hydraulic coverage.
- **Thrust Washer:** Designed for extra margin of safety against possible momentary upthrust occurring at start-up.
- **Intermediate Bowl Bearings:** Reliable long life Bismuth bronze bearing is standard. Optional rubber or other materials available.
- **Taper Locks:** Accurately machined in 316SS to insure positive locking of impeller to pump shaft.
- **Suction Inlet:** Contoured for smooth flow entrance. Protected by an oversized 304 stainless steel strainer to prevent entrance of damaging solids.

- **Motor Adapter:** Cast 316 stainless steel for corrosion resistance, increased strength and positive motor alignment. Permits easy access to pump/motor coupling.
- **Pump to Motor Coupling:** Large stainless steel coupling accurately matched for perfect alignment, balance and power transmission.
- **Pump Shaft:** 316 stainless steel provides strength and excellent corrosion resistance. Ground and polished for smooth bearing surface.
- **Powered for Continuous Operation:** All ratings are within the working limits of the motor manufacturer. Pump can be operated continuously without fear of damage to the motor.

- **Submersible Motor:**
  - 316 stainless steel corrosion resistant construction
  - 316 stainless steel splined shaft
  - Hermetically sealed windings
  - Anti-track self-healing resin system
  - Water lubrication
  - Kingsbury type thrust bearing
  - Pressure equalizing diaphragm
  - Sand fighter slinger
  - UL 778 recognized.

Goulds Pumps

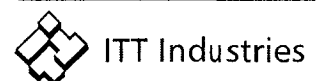

# Model 7TNLC 316 Stainless Steel Pump

## Single Stage Performance Curve

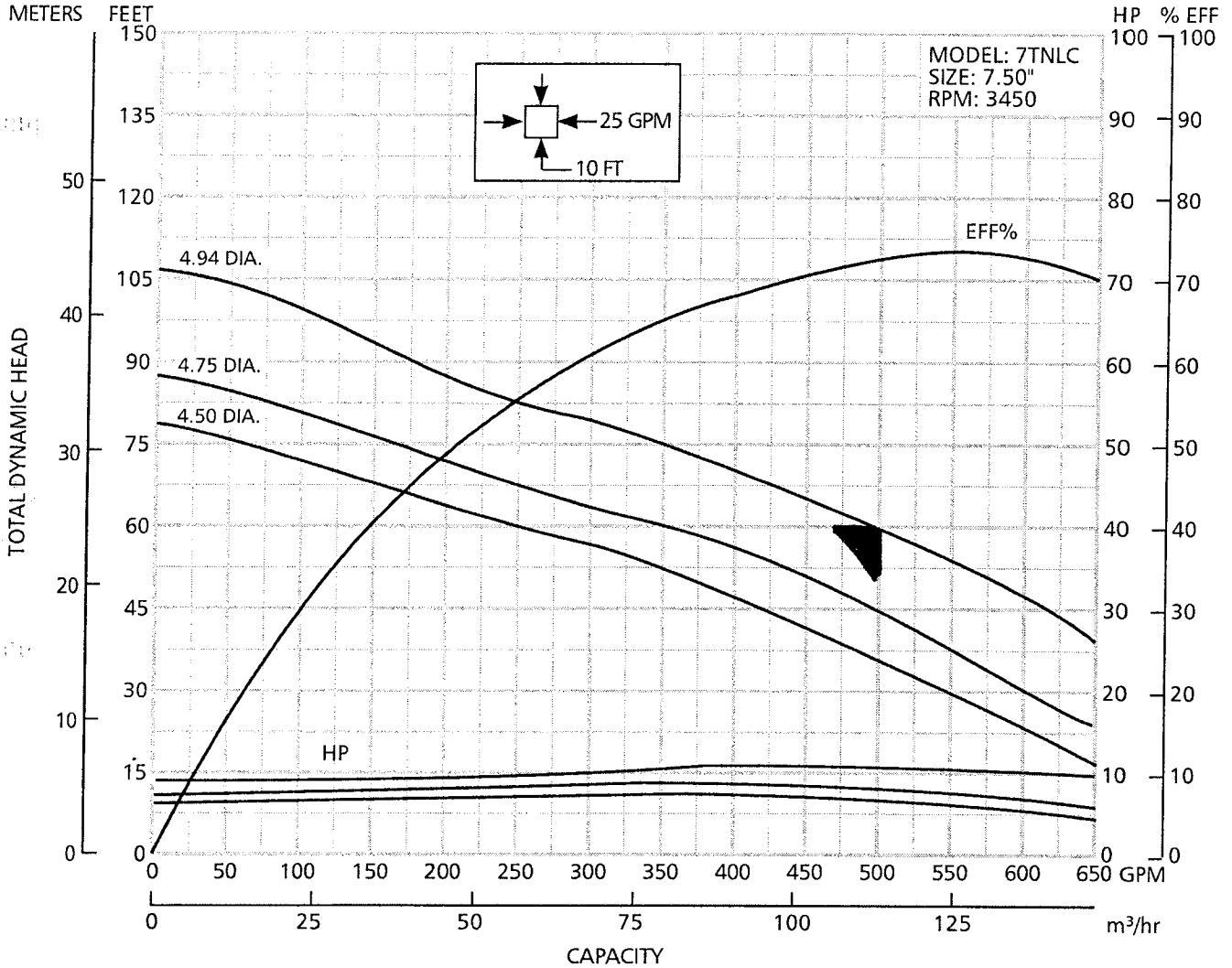

Characteristics based upon pumping clear non-aerated water.  
Rating point only is guaranteed. Column and other losses not included.

### SPECIFICATIONS

- RPM: 3450, 60 Hz
- Max. O.D. with Cable Guard: 7.5"
- Minimum Well Size: 8"
- Available Discharge Size: 4" & 6"
- Available Motor Size: 6", 8"
- Bowl Connection: Bolted
- Impeller: Enclosed Type
- Bearing Material: Bronze, other materials available.
- Thrust Constant (K): 4.50 lbs./ft.
- Specific Speed: 3684
- Maximum Shutoff Head: 412 PSI / 952 Feet
- Maximum Number of Stages: 8
- Efficiency Correction:
  - 1 Stage deduct 3.0
  - 2 Stages deduct 2.0
  - 3 Stages deduct 1.0

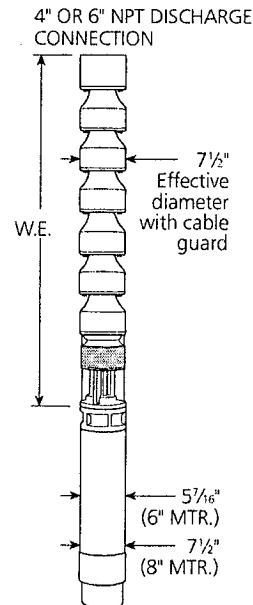

Curves reflect typical performance, refer to factory for certification.

D/E Project Number: 17952-37853  
 CDM Job Number: 41798  
 Name of Project: Dare County Wellfield Expansion – Wells  
 Project Designation:  
 Name of Subcontractor or Material Supplier: Goulds Pumps  
 Referenced Contract Drawing #: \_\_\_\_\_  
 Referenced Specification Section: \_\_\_\_\_ 11216 \_\_\_\_\_  
 Name of Manufacturer: Goulds Pumps  
 Manufacturer Phone No.: \_\_\_\_\_ Contact: \_\_\_\_\_  
 Description: Certified Factory Test Report  
 Location of use: Well #15

D-11216-01Z-A SHOP DRAWING  
 CONTROL NUMBER  
 1  
 REVIEW CODE PER  
 SECTION 01300

SHOP DRAWING REVIEW	
ENGINEER'S REVIEW	RESPONSE REQUIRED OF CONTRACTOR
<input checked="" type="checkbox"/> Approved <input type="checkbox"/> Approved as Noted <input type="checkbox"/> Not Approved	<input type="checkbox"/> Comments Attached <input type="checkbox"/> Confirm <input type="checkbox"/> Resubmit
<input type="checkbox"/> Receipt Acknowledged (Not subject to Engineer's Review or Approval)	
<p>The Engineer's review of this shop drawing is limited to the review of dimensions, equipment and materials as presented in the Contract plans, specifications, and for design concept. This review does not relieve the Contractor from errors or omissions in the submittal or from the Contractor's responsibility of addressing any deviations from the Contract Documents. The Contractor is responsible for the details and dimensions of fabrication and manufacture, the means, methods, techniques, sequences or procedures of construction and performing its work in a safe manner.</p>	
CDM by <u>GAS / TRS</u> Date <u>07-07-04</u>	

WELL # 15



ITT INDUSTRIES - GOULDS PUMPS - TURBINE OPERATION  
PERFORMANCE TEST RESULTS



CUSTOMER: A.C. SCHULTES  
P.O. NUMBER: 10507

PROJECT: TIM PRUIT SS/SUB

S.O. NUMBER: 482077  
DATE: 06/15/04

CONDITIONS

PUMP NUM:	1	SP. GR:	1.00	BOWL TDH:	310.0
PUMP TYPE:	VIS	VISC. SSU:	32	PUMP TDH:	0.0
PUMP MODEL:	7TNLC	WATER TEMP:F	73	REQ GPM:	500
STAGES:	6	WITNESSED:	N	MAX GPM:	650
IMP. MATL:	1203	MOTOR SER. #:	17-0021	EFFICIENCY:%	71.6
1ST IMP. DIA:	4.50	1ST IMP. QTY:	6	TEST RPM:	3450
2ND IMP. DIA:	0.00	2ND IMP. QTY:	0	TEST MOTOR:	60 HP
CUST RPM:	3480	TESTED BY:	CHAD HAYDEN	TEST LINE:	4
CUST HP:	60			CURVE RPM:	3480

READINGS DURING TEST

POINTS	1	2	3	4	5	6	7
PSI	252.2	233.9	205.9	169.5	132.3	102.0	71.4
DISCH. FT.	582.58	540.31	475.63	391.55	305.61	235.62	164.93
ELEV. FT.	5.00	5.00	5.00	5.00	5.00	5.00	5.00
VEL. FT.	0.00	0.02	0.10	0.27	0.49	0.66	0.83
PIPE FRIC.	0.00	0.00	0.01	0.03	0.05	0.06	0.08
TORQUE	79.16	76.46	72.34	74.03	73.86	69.58	64.70
INPUT KW	46.90	45.40	43.40	44.10	44.00	41.50	38.60
AMPERES	73.90	72.30	69.50	70.80	70.60	68.30	65.20
VIBRATION	-	-	-	-	-	-	-

TEST DATA RECORDED AT TEST RPM

RPM	3499	3503	3509	3507	3507	3513	3519
GPM	0	101	232	373	504	586	657
TDH-FEET	587.6	545.3	480.7	396.8	311.1	241.3	170.8
PUMP HP	52.8	51.0	48.3	49.4	49.3	46.6	43.4
PUMP EFF	0.0	27.2	58.2	75.6	80.2	76.6	65.4

TEST DATA CONVERTED TO CUSTOMER RPM

RPM	3480	3480	3480	3480	3480	3480	3480
GPM	0	100	230	370	500	580	650
TDH-FEET	581.1	538.3	472.9	390.9	306.4	236.8	167.0
PUMP HP	51.9	50.0	47.2	48.3	48.2	45.3	41.9
PUMP EFF	0.0	27.2	58.2	75.6	80.2	76.6	65.4

Certified Test Results

By: Don Hollist  
 Title: ENGINEER  
 Date: June 16,2004

# ITT - Goulds Pumps Turbine Operations

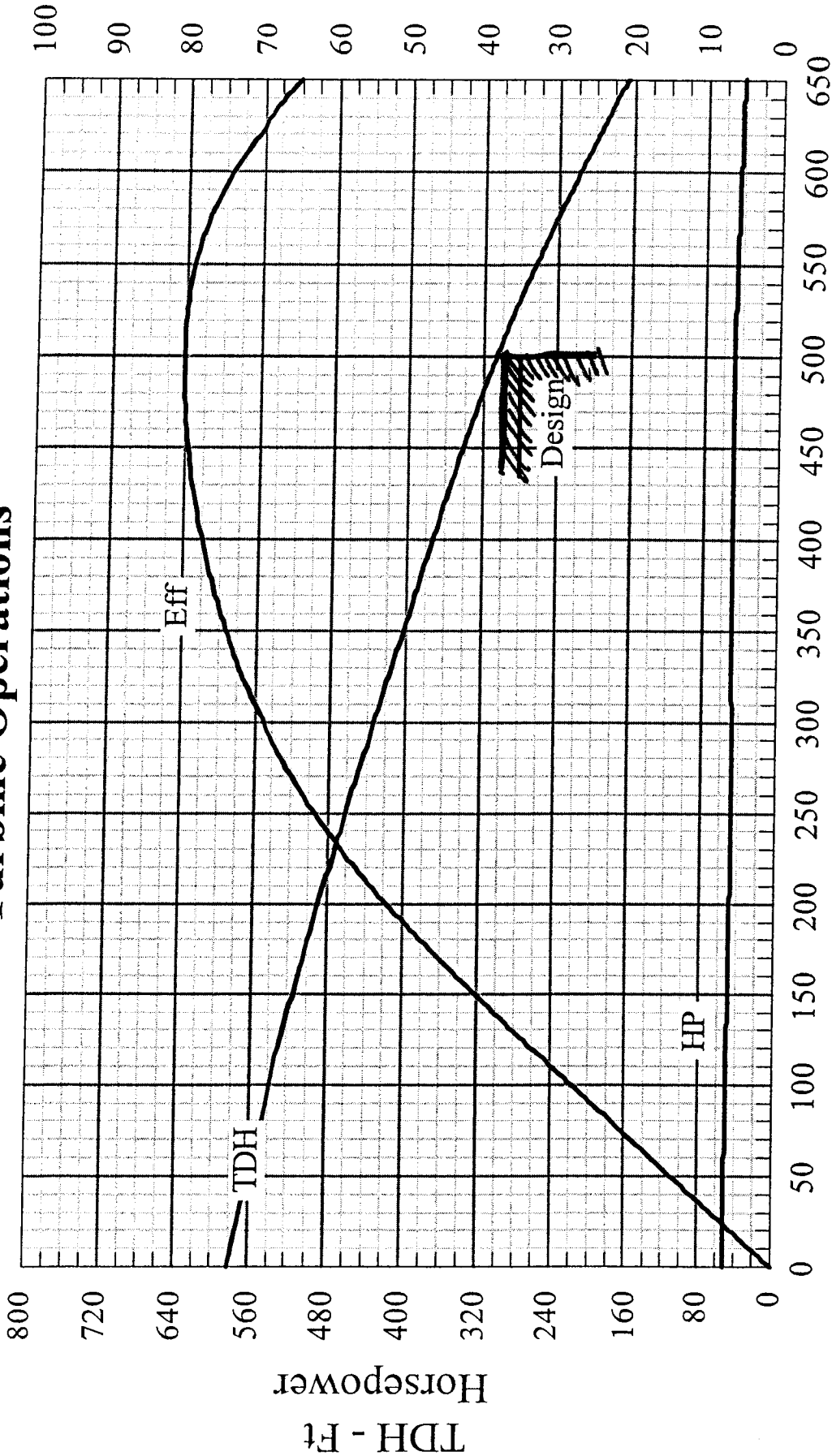

SO: 482077  
Model: 7TNCL

Imp Dia: 4.50 in  
Speed: 3480RPM

Flow - GPM  
Certified Test Results

By: Don Holler  
Title: Engineer  
Date: June 16, 2004





9311 College Parkway, Suite 1  
Fort Myers, Florida 33919  
tel: 239 432-9494  
fax: 239 432-9453

March 4, 2005

Harry F. Bailey  
Environmental Engineer  
Public Water Supply Section  
Department of Environment and Natural Resources  
943 Washington Square Mall  
Washington, NC 27889

Subject: Well Completion Statement for Production Well Nos. 15 and Orville  
Dare County Water System  
PWS ID 04-28-030, Dare County

Dear Mr. Bailey:

The purpose of this letter is to advise you that to the best of my knowledge, information and belief, the construction of Production Well No. 15 and Orville has been completed in accordance with the requirements of the State of North Carolina.

If you have any questions or I can be of any further assistance, please do not hesitate to call either me (239/432-9494) or Gary St. John (757/873-8850).

Sincerely,

  
Wm. Scott Manahan, P.E.  
Camp Dresser & McKee Inc.

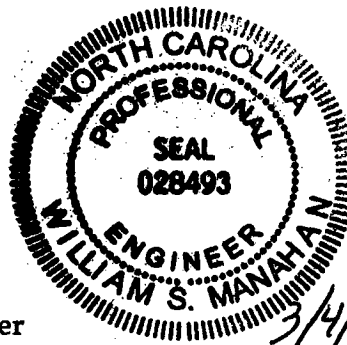

cc: Ken Flatt - Dare County Water  
Gary St. John - CDM

**The Easement from North Carolina is pending. Copy will be sent under separate cover.**



ANALYTICAL & CONSULTING  
CHEMISTS

# Environmental Chemists, Inc.

6602 Windmill Way • Wilmington, NC 28405  
(910) 392-0223 (Lab) • (910) 392-4424 (Fax)  
710 Bowsertown Road • Manteo, NC 27954  
(252) 473-5702

NC DENR: DWQ CERTIFICATE #94. DLS CERTIFICATE #37729

## A.C. Schultes

Index for Dare Co. Well # 15

Sample # 18808 Report 4-8499

Collected 12/22/04 @ 07:30 am

- Page 1 & 2 : New Well Inorganics ( State Form)
- Page 3: TOC / DOC (State Form)
- Page 4 : THM Formation Potential
- Page 5 & 6: Volatile Organic Chemicals (VOCs) (State Form)
- Page 7 & 8: Pesticides and Synthetic Organic Chemicals (SOC) (State Form)
- Page 9: Asbestos (State Form)
- Page 10: Radiological (State Form)
- Page 11: Bacteriological (State Form)
- Page 12: Sample Collection Sheet



Analytical & Consulting Chemists

**Environmental Chemists, Inc.**

6602 Windmill Way • Wilmington, North Carolina 28405

(910) 392-0223 Phone • (910) 392-4424 Fax

ECChemW@aol.com

NCDENR: DWQ Certificate #94, DLS Certificate #37729

**NEW WELL INORGANIC CHEMICAL ANALYSIS**

Page 1 of 12

Note: All information must be supplied for plan review credit.

WATER SYSTEM ID #: \_\_\_\_\_ County: \_\_\_\_\_ Dare

Name of Water System: \_\_\_\_\_ Dare Co.

Sample Type: X Source for Plan Review

Location Where Collected: \_\_\_\_\_ Well # 15  
(Note: Compliance sample MUST be collected at the entry point.)

Location Code: \_\_\_\_\_ Collection Date \_\_\_\_\_ Collection Time \_\_\_\_\_

Collected By: \_\_\_\_\_ Kevin Schultes \_\_\_\_\_ 12/22/04 \_\_\_\_\_ 07:30 AM \_\_\_\_\_  
(Please Print) (MM/DD/YY) (Specify AM or PM)

Mail Results to (water system representative):  
 \_\_\_\_\_ A.C. Schultes \_\_\_\_\_  
 \_\_\_\_\_ 3887 S. NC 41 \_\_\_\_\_  
 \_\_\_\_\_ Wallace, NC 28466 \_\_\_\_\_

Phone #: (\_\_\_\_) \_\_\_\_\_  
 Fax #: (\_\_\_\_) \_\_\_\_\_

LABORATORY ID #: 37729

SAMPLE UNSATISFACTORY  RESAMPLE REQUIRED

CONTAM CODE	CONTAMINANT	METHOD CODE	REQUIRED REPORTING LIMIT (R.R.L.)	NOT DETECTED (i.e. < R.R.L.) (X)	QUANTIFIED RESULTS*	ALLOWABLE LIMIT
0100	Turbidity	001	0.10 ntu	<input type="checkbox"/>	0.5 mg/L	N/A
1005	Arsenic	169	0.005 mg/L	X	mg/L	0.010 mg/L
1010	Barium	169	0.400 mg/L	X	mg/L	2.000 mg/L
1015	Cadmium	169	0.001 mg/L	X	mg/L	0.005 mg/L
1016	Calcium	169	0.001 mg/L	<input type="checkbox"/>	49. mg/L	N/A
1017	Chloride	128	5.0 mg/L	<input type="checkbox"/>	1508. mg/L	250.0 mg/L
1020	Chromium	169	0.020 mg/L	X	mg/L	0.100 mg/L
1022	Copper	169	0.050 mg/L	X	mg/L	1.300 mg/L
1024	Cyanide	154	0.040 mg/L	<input type="checkbox"/>	0.06 mg/L	0.200 mg/L
1025	Fluoride	107	0.100 mg/L	<input type="checkbox"/>	0.6 mg/L	4.000 mg/L
1028	Iron	169	0.060 mg/L	<input type="checkbox"/>	0.091 mg/L	0.300 mg/L
1030	Lead	125	0.003 mg/L	X	mg/L	0.015 mg/L
1031	Magnesium	169	1.0 mg/L	<input type="checkbox"/>	153. mg/L	N/A
1032	Manganese	169	0.010 mg/L	X	mg/L	0.050 mg/L
1035	Mercury	103	0.0004 mg/L	X	mg/L	0.002 mg/L

\*Note: Concentrations for Lead and Copper are action levels, not MCLs.

# 18308 4-8499



Analytical & Consulting Chemists

# Environmental Chemists, Inc.

6602 Windmill Way • Wilmington, North Carolina 28405

(910) 392-0223 Phone • (910) 392-4424 Fax

EChemW@aol.com

NCDENR: DWQ Certificate #94, DLS Certificate #37729

## NEW WELL INORGANIC CHEMICAL ANALYSIS

(Continued)

Note: All information must be supplied for plan review credit.

WATER SYSTEM ID #: Dare Co. Well # 15

Collection Date

Collection Time

Location Code: \_\_\_\_\_

12/22/04  
(MM/DD/YY)

07:30 AM  
(Specify AM or PM)

LABORATORY ID #: **37729**

CONTAM CODE	CONTAMINANT	METHO D CODE	REQUIRED REPORTING LIMIT (R.R.L.)	NOT DETECTED (i.e. <R.R.L.) (X)	QUANTIFIED RESULTS*	ALLOWABLE LIMIT
1036	Nickel	169	0.100 mg/L	X	_____ mg/L	N/A
1040	Nitrate	109	1.00 mg/L	X	_____ mg/L	10.00 mg/L
1041	Nitrite	109	0.10 mg/L	X	_____ mg/L	1.00 mg/L
1045	Selenium	125	0.010 mg/L	X	_____ mg/L	0.050 mg/L
1050	Silver	169	0.05 mg/L	X	_____ mg/L	0.100 mg/L
1052	Sodium	169	1.0 mg/L	□	<u>3688.</u> mg/L	N/A
1055	Sulfate	173	5.0 mg/L	X	_____ mg/L	250.0 mg/L
1068	Acidity	144	1.0 mg/L	□	<u>9.8</u> mg/L	N/A
1074	Antimony	125	0.003 mg/L	X	_____ mg/L	0.006 mg/L
1075	Beryllium	169	0.002 mg/L	X	_____ mg/L	0.004 mg/L
1085	Thallium	125	0.001 mg/L	X	_____ mg/L	0.002 mg/L
1095	Zinc	169	1.0 mg/L	X	_____ mg/L	5.0 mg/L
1905	Color	129	5 units	□	<u>51.</u> mg/L	15 units
1915	Total Hardness	141	1.0 mg/L	□	<u>230.</u> mg/L	N/A
1925	pH	<u>135</u>	N/A	N/A	<u>8.12</u> Units	6.50 - 8.50 units
1924	Alkalinity	142	1.0 mg/L	□	<u>589</u> mg/L	N/A
1930	Total Dissolved Solids	160	10.0 mg/L	□	<u>3038.</u> mg/L	500.0 mg/L

\*Note: Concentrations for Lead and Copper are action levels, not MCLs.

ANALYSES BEGUN:	DATE:	TIME:
	<u>12/23/04</u> (MM/DD/YY)	<u>09:00 AM</u> (Specify AM or PM)
ANALYSES COMPLETED:	DATE:	TIME:
	<u>01/06/05</u> (MM/DD/YY)	<u>04:00 PM</u> (Specify AM or PM)

Laboratory Log #: 18808

Certified By: \_\_\_\_\_

*Jenifer Hicks*  
(Print and sign name)

COMMENTS: \_\_\_\_\_

REPORT # 4-8499

**TOC Requirements-Disinfection Byproduct Precursor Analysis** PAGE 3 of 12  
 Note: All information must be supplied for compliance credit

Water System ID#: \_\_\_\_\_

County: Dare

Name of Water System: Dare County

Sample Type:  Source  Treated  Special/Non-compliance

Location Where Collected: Well # 15

(Note: sample MUST be collected from Maximum Chlorine Residence or Distribution sites)

Location Code: \_\_\_\_\_

Collection Date  
12/22/04  
 (MM/DD/YY)

Collection Time  
07:30 AM  
 (Specify AM or PM)

Collected By: Kevin Schultes

Mail Results to (water system representative):

A.C. Schultes of Carolina, Inc.

3887 S. NC 41

Wallace, NC 28466

Telephone No. (\_\_\_\_\_) \_\_\_\_\_

Fax No. (\_\_\_\_\_) \_\_\_\_\_

Responsible person's email: \_\_\_\_\_

Laboratory ID#: 37729

SAMPLE UNSATISFACTORY

RESAMPLE REQUIRED

CONTAM CODE	CONTAMINANT	METHOD CODE			REQUIRED REPORTING LIMIT (R.R.L.)		LESS THAN R.R.L. (X)	QUANTIFIED RESULTS*				ALLOWABLE LIMIT	
1927	Alkalinity				1.0	mg/L	<input type="checkbox"/>					mg/L	N/A
2920	Total Organic Carbon (TOC)	<u>1</u>	<u>7</u>	<u>5</u>	1.0	mg/L	<input type="checkbox"/>		<u>1</u>	<u>0</u>	<u>1</u>	mg/L	N/A
2919	Dissolved Organic Carbon	<u>1</u>	<u>7</u>	<u>5</u>	1.0	mg/L	<input type="checkbox"/>			<u>8</u>	<u>8</u>	mg/L	N/A
2922	Ultraviolet Absorption 254 (UV254)				1.0	mg/L	<input type="checkbox"/>					mg <sup>-1</sup>	N/A

	DATE:	TIME:
Analysis Begun:	<u>12/29/04</u>	<u>01:40 PM</u>
Analysis Completed:	<u>12/29/04</u>	<u>02:59 PM</u>

Laboratory Log #: 18808

Certified By: \_\_\_\_\_

(Print and Sign Name)

REMARKS:

Bottle ID # \_\_\_\_\_

Report # 4-8499



ANALYTICAL & CONSULTING CHEMISTS

# Environmental Chemists, Inc.

6602 Windmill Way • Wilmington, NC 28405  
(910) 392-0223 (Lab) • (910) 392-4424 (Fax)  
710 Bowsertown Road • Manteo, NC 27954  
(252) 473-5702

NC DENR: DWQ CERTIFICATE #94. DLS CERTIFICATE #37729

**Customer:**

**A.C. SCHULTES**  
3887 S. NC 41  
Wallace, NC 28466  
Attn: Bill Jefferys

**Date of Report:** January 12, 2005

**Purchase Order No.:**

**Report Number:** 4-8499

## REPORT OF ANALYSIS

Page 4 of 12

**Date Collected:** 12/22/04

**Report To:** Bill Jefferys

**Sampled By:** Kevin Schultes

**Project:** Dare Co. #15

**I.D. # 18808**

### TRIHALOMETHANE FORMATION POTENTIAL

**Chlorine Residual after incubation = 1.0 ppm Cl<sub>2</sub> from a 30.0 ppm dose**

#### THMFP Analysis

**Chloroform mg/L = 0.0028**  
**Bromoform mg/L = 0.0457**  
**Chlorodibromomethane mg/L = 0.0199**  
**Bromodichloromethane mg/L = 0.0139**

**TFP mg/L = 0.0823**

**4 hour Chlorine Demand = 24 ppm Cl<sub>2</sub>**

**Reviewed by** \_\_\_\_\_



Analytical & Consulting Chemists

Environmental Chemists, Inc.

6602 Windmill Way • Wilmington, North Carolina 28405

(910) 392-0223 Phone • (910) 392-4424 Fax EChemW@aol.com

NCDENR: DWO Certificate #94, DLS Certificate #37729

VOLATILE ORGANIC CHEMICALS ANALYSIS (VOCs)

Note: All information must be supplied for compliance credit.

PAGE 5 of 12

WATER SYSTEM ID #: \_\_\_\_\_

County \_\_\_\_\_ Date \_\_\_\_\_

Name of Water System: Dare County

Sample Type:  Entry Point  Special/Non-compliance

Location Where Collected: Well # 15

(Note: Compliance samples MUST be collected at the Entry Point)

Location Code: \_\_\_\_\_

Collected By: Kevin Schultes  
(Please Print)

Collection Date

Collection Time

12/22/04  
(MM/DD/YY)

07:30 AM  
(Specify AM or PM)

Mail Results to (water system representative):

A.C. Schultes

3887 S. NC 41

Wallace, NC 28466

Phone #: (910) \_\_\_\_\_

Fax #: (910) \_\_\_\_\_

\*NOTE: Please complete portion above double line on Page 2.

LABORATORY ID #: 37729

SAMPLE UNSATISFACTORY

RESAMPLE REQUIRED

CONTAM CODE	CONTAMINANT	METHOD CODE	REQUIRED REPORTING LIMIT (R.R.L.)	NOT DETECTED (i.e. < R.R.L.) (X)	QUANTIFIED RESULTS*	ALLOWABLE LIMIT
2030	p-Isopropyltoluene	2 2 1	0.0005 mg/L	X	-----	mg/L N/A
2210	Chloromethane	2 2 1	0.0005 mg/L	X	-----	mg/L N/A
2212	Dichlorodifluoromethane	2 2 1	0.0005 mg/L	X	-----	mg/L N/A
2214	Bromomethane	2 2 1	0.0005 mg/L	X	-----	mg/L N/A
2216	Chloroethane	2 2 1	0.0005 mg/L	X	-----	mg/L N/A
2218	Fluorotrichloromethane	2 2 1	0.0005 mg/L	X	-----	mg/L N/A
2246	Hexachlorobutadiene	2 2 1	0.0005 mg/L	X	-----	mg/L N/A
2248	Naphthalene	2 2 1	0.0005 mg/L	X	-----	mg/L N/A
2378	1,2,4-Trichlorobenzene	2 2 1	0.0005 mg/L	X	-----	mg/L 0.07 mg/L
2380	Cis-1,2-Dichloroethylene	2 2 1	0.0005 mg/L	X	-----	mg/L 0.07 mg/L
2408	Dibromomethane	2 2 1	0.0005 mg/L	X	-----	mg/L N/A
2410	1,1-Dichloropropene	2 2 1	0.0005 mg/L	X	-----	mg/L N/A
2412	1,3-Dichloropropane	2 2 1	0.0005 mg/L	X	-----	mg/L N/A
2413	1,3-Dichloropropene	2 2 1	0.0005 mg/L	X	-----	mg/L N/A
2414	1,2,3-Trichloropropane	2 2 1	0.0005 mg/L	X	-----	mg/L N/A
2416	2,2-Dichloropropane	2 2 1	0.0005 mg/L	X	-----	mg/L N/A
2418	1,2,4-Trimethylbenzene	2 2 1	0.0005 mg/L	X	-----	mg/L N/A
2420	1,2,3-Trichlorobenzene	2 2 1	0.0005 mg/L	X	-----	mg/L N/A
2422	n-Butylbenzene	2 2 1	0.0005 mg/L	X	-----	mg/L N/A
2424	1,3,5-Trimethylbenzene	2 2 1	0.0005 mg/L	X	-----	mg/L N/A
2426	Tert-Butylbenzene	2 2 1	0.0005 mg/L	X	-----	mg/L N/A
2428	Sec-Butylbenzene	2 2 1	0.0005 mg/L	X	-----	mg/L N/A
2430	Bromochloromethane	2 2 1	0.0005 mg/L	X	-----	mg/L N/A
2941	Chloroform	2 2 1	0.0005 mg/L	X	-----	mg/L N/A

\*Note: If result exceeds allowable limit, the laboratory must fax analytical results to the State within 48 hours

# 18808

Report # 4-8499





Analytical & Consulting Chemists

Environmental Chemists, Inc.  
6602 Windmill Way • Wilmington, North Carolina 28405

(910) 392-0223 Phone • (910) 392-4124 Fax EChemW@aol.com

NCDENR: DWO Certificate #94. DLS Certificate #37729

(VOLATILE ORGANIC CHEMICALS ANALYSIS (VOCs))

Note: All information must be supplied for compliance credit continued)

WATER SYSTEM ID #: Dare Co. Well # 15

Location Code: \_\_\_\_\_

<b>Collection Date</b> <u>12/22/04</u> <small>(MM/DD/YY)</small>	<b>Collection Time</b> <u>07:30 AM</u> <small>(Specify AM or PM)</small>
------------------------------------------------------------------------	--------------------------------------------------------------------------------

LABORATORY ID #: 37729

CONTAM CODE	CONTAMINANT	METHOD CODE	REQUIRED REPORTING LIMIT (R.R.L.)	NOT DETECTED ABOVE R.R.L. (X)	QUANTIFIED RESULTS*	ALLOWABLE LIMIT
2942	Bromoform	221	0.0005 mg/L	X	-----	N/A
2943	Bromodichloromethane	221	0.0005 mg/L	X	-----	N/A
2944	Chlorodibromomethane	221	0.0005 mg/L	X	-----	N/A
2955	Xylenes (Total)	221	0.0005 mg/L	X	-----	N/A
2964	Dichloromethane	221	0.0005 mg/L	X	-----	10.00 mg/L
2965	o-Chlorotoluene	221	0.0005 mg/L	X	-----	0.005 mg/L
2966	p-Chlorotoluene	221	0.0005 mg/L	X	-----	N/A
2967	m-Dichlorobenzene	221	0.0005 mg/L	X	-----	N/A
2968	o-Dichlorobenzene	221	0.0005 mg/L	X	-----	N/A
2969	p-Dichlorobenzene	221	0.0005 mg/L	X	-----	0.60 mg/L
2976	Vinyl Chloride	221	0.0005 mg/L	X	-----	0.075 mg/L
2977	1,1-Dichloroethylene	221	0.0005 mg/L	X	-----	0.002 mg/L
2978	1,1-Dichloroethane	221	0.0005 mg/L	X	-----	0.007 mg/L
2979	Trans-1,2-Dichloroethylene	221	0.0005 mg/L	X	-----	N/A
2980	1,2-Dichloroethane	221	0.0005 mg/L	X	-----	0.10 mg/L
2981	1,1,1-Trichloroethane	221	0.0005 mg/L	X	-----	0.005 mg/L
2982	Carbon Tetrachloride	221	0.0005 mg/L	X	-----	0.20 mg/L
2983	1,2-Dichloropropane	221	0.0005 mg/L	X	-----	0.005 mg/L
2984	Trichloroethylene	221	0.0005 mg/L	X	-----	0.005 mg/L
2985	1,1,2-Trichloroethane	221	0.0005 mg/L	X	-----	0.005 mg/L
2986	1,1,1,2-Tetrachloroethane	221	0.0005 mg/L	X	-----	0.005 mg/L
2987	Tetrachloroethylene	221	0.0005 mg/L	X	-----	N/A
2988	1, 1,2,2-Tetrachloroethane	221	0.0005 mg/L	X	-----	0.005 mg/L
2989	Chlorobenzene	221	0.0005 mg/L	X	-----	N/A
2990	Benzene	221	0.0005 mg/L	X	-----	0.10 mg/L
2991	Toluene	221	0.0005 mg/L	X	-----	0.005 mg/L
2992	Ethylbenzene	221	0.0005 mg/L	X	-----	1.00 mg/L
2993	Bromobenzene	221	0.0005 mg/L	X	-----	0.70 mg/L
2994	Isopropylbenzene	221	0.0005 mg/L	X	-----	N/A
2996	Styrene	221	0.0005 mg/L	X	-----	N/A
2998	n-Propylbenzene	221	0.0005 mg/L	X	-----	0.10 mg/L

\*Note: If result exceeds allowable limit, the laboratory must fax analytical results to the State within 48 hours

<b>ANALYSES BEGUN:</b>	<b>DATE:</b> <u>12/22/04</u> <small>(MM/DD/YY)</small>	<b>TIME:</b> <u>05:00 PM</u> <small>(Specify AM or PM)</small>
<b>ANALYSES COMPLETED:</b>	<u>01/04/05</u> <small>(MM/DD/YY)</small>	<u>03:00 PM</u> <small>(Specify AM or PM)</small>

Laboratory Log #: 18808

Certified By: Jenice Hester  
(Print and sign name)

COMMENTS: \_\_\_\_\_

REPORT # 4-8499



Analytical & Consulting Chemists

Environmental Chemists, Inc.

6602 Windmill Way • Wilmington, North Carolina 28405

(910) 392-0223 Phone • (910) 392-4424 Fax EChemW@aol.com

NCDENR: DWO Certificate #94. DLS Certificate #37729

PESTICIDES AND SYNTHETIC ORGANIC CHEMICALS ANALYSIS (SOCs) PAGE 7 of 12

Note: All information must be supplied for compliance credit.

WATER SYSTEM ID #: \_\_\_\_\_ County: Dare

Name of Water System: Dare County Well

Sample Type:  Entry Point  Special/Non-compliance

Location Where Collected: Well # 15  
(Note: Compliance sample MUST be collected at the Entry Point.)

Location Code: \_\_\_\_\_

<b>Collection Date</b>	<b>Collection Time</b>
<u>12/22/04</u> <small>(MM/DD/YY)</small>	<u>07:30 AM</u> <small>(Specify AM or PM)</small>

Collected By: Kevin Schultes  
(Please Print)

Mail Results to (water system representative):  
A.C. Schultes  
3887 S. NC 41  
Wallace, NC 28466

Phone #: (910) \_\_\_\_\_

Fax #: (910) \_\_\_\_\_

\*NOTE: Please complete portion above double line on Page 2.

LABORATORY ID #: 37729

SAMPLE UNSATISFACTORY

RESAMPLE REQUIRED

CONTAM CODE	CONTAMINANT	METHOD CODE	REQUIRED REPORTING LIMIT (R.R.L.)	NOT DETECTED (i.e. <R.R.L.) (X)	QUANTIFIED RESULTS*	ALLOWABLE LIMIT
2005	Endrin	221	0.00001 mg/L	X	_____ mg/L	0.002 mg/L
2010	Lindane	210	0.00002 mg/L	X	_____ mg/L	0.0002 mg/L
2015	Methoxychlor	210	0.0001 mg/L	X	_____ mg/L	0.04 mg/L
2020	Toxaphene	210	0.001 mg/L	X	_____ mg/L	0.003 mg/L
2021	Carbaryl	235	0.004 mg/L	X	_____ mg/L	N/A
2022	Methomyl	235	0.004 mg/L	X	_____ mg/L	N/A
2031	Dalapon	203	0.001 mg/L	X	_____ mg/L	0.2 mg/L
2035	Di(2-ethylhexyl)adipate	225	0.0006 mg/L	X	_____ mg/L	0.4 mg/L
2036	Oxamyl(vydate)	235	0.002 mg/L	X	_____ mg/L	0.2 mg/L
2037	Simazine	210	0.00007 mg/L	X	_____ mg/L	0.004 mg/L
2040	Picloram	203	0.0001 mg/L	X	_____ mg/L	0.5 mg/L
2041	Dinoseb	203	0.0002 mg/L	X	_____ mg/L	0.007 mg/L
2042	Hexachlorocyclopentadiene	210	0.0001 mg/L	X	_____ mg/L	0.05 mg/L
2043	Aldicarb Sulfoxide	235	0.0005 mg/L	X	_____ mg/L	N/A
2044	Aldicarb Sulfone	235	0.0008 mg/L	X	_____ mg/L	N/A
2045	Metolachlor	210	0.0008 mg/L	X	_____ mg/L	N/A
2046	Carbofuran	235	0.0009 mg/L	X	_____ mg/L	0.04 mg/L
2047	Aldicarb	235	0.0005 mg/L	X	_____ mg/L	N/A
2050	Atrazine	210	0.0001 mg/L	X	_____ mg/L	0.003 mg/L
2051	Alachlor	210	0.0002 mg/L	X	_____ mg/L	0.002 mg/L
2065	Heptachlor	210	0.00004 mg/L	X	_____ mg/L	0.0004 mg/L

\* Note: If result exceeds allowable limit, the laboratory must fax analytical results to the State within 48 hours.

# 18808

4-8499



Analytical & Consulting Chemists

Environmental Chemists, Inc.  
6602 Windmill Way • Wilmington, North Carolina 28405

(910) 392-0223 Phone • (910) 392-4424 Fax EChemW@aol.com

NCDENR: DWO Certificate #94. DLS Certificate #37729

PESTICIDES AND SYNTHETIC ORGANIC CHEMICALS ANALYSIS (SOCs) PAGE 8 of 12

(continued)  
Note: All information must be supplied for compliance credit.

WATER SYSTEM ID #: Dare Co. Well # 15

Location Code: \_\_\_\_\_

<b>Collection Date</b>	<b>Collection Time</b>
<u>12/22/04</u> <small>(MM/DD/YY)</small>	<u>07:30 AM</u> <small>(Specify AM or PM)</small>

LABORATORY ID #: 3 7 7 2 9

CONTAM CODE	CONTAMINANT	METHOD CODE	REQUIRED REPORTING LIMIT (R.R.L.)	NOT DETECTED ABOVE R.R.L. (X)	QUANTIFIED RESULTS*	ALLOWABLE LIMIT
2066	3-Hydroxycarbofuran	<u>235</u>	0.004 mg/L	X	----- mg/L	N/A
2067	Heptachlor Epoxide	<u>210</u>	0.00002 mg/L	X	----- mg/L	0.0002 mg/L
2070	Dieldrin	<u>210</u>	0.0002 mg/L	X	----- mg/L	N/A
2076	Butachlor	<u>210</u>	0.008 mg/L	X	----- mg/L	N/A
2077	Propachlor	<u>210</u>	0.006 mg/L	X	----- mg/L	N/A
2105	2,4-D	<u>203</u>	0.0001 mg/L	X	----- mg/L	0.07 mg/L
2110	2,4,5-TP (Silvex)	<u>203</u>	0.0002 mg/L	X	----- mg/L	0.05 mg/L
2274	Hexachlorobenzene	<u>210</u>	0.0001 mg/L	X	----- mg/L	0.001 mg/L
2298	Di(2-ethylhexyl)phthalate	<u>225</u>	0.00132 mg/L	X	----- mg/L	0.006 mg/L
2306	Benzo(a)pyrene	<u>225</u>	0.00002 mg/L	X	----- mg/L	0.0002 mg/L
2326	Pentachlorophenol	<u>203</u>	0.00004 mg/L	X	----- mg/L	0.001 mg/L
2356	Aldrin	<u>210</u>	0.0002 mg/L	X	----- mg/L	N/A
2383	PCB's	<u>210</u>	0.0001 mg/L	X	----- mg/L	0.0005 mg/L
2440	Dicamba	<u>203</u>	0.001 mg/L	X	----- mg/L	N/A
2595	Metribuzin	<u>210</u>	0.0008 mg/L	X	----- mg/L	N/A
2931	DBCP	<u>219</u>	0.00002 mg/L	X	----- mg/L	0.0002 mg/L
2946	Ethylene Dibromide (EDB)	<u>219</u>	0.00001 mg/L	X	----- mg/L	0.00005 mg/L
2959	Chlordane	<u>210</u>	0.0002 mg/L	X	----- mg/L	0.002 mg/L

\*Note: If result exceeds allowable limit, the laboratory must fax analytical results to the State within 48 hours.

<b>ANALYSES BEGUN:</b>	<b>DATE:</b>	<b>TIME:</b>
	<u>12/27/04</u> <small>(MM/DD/YY)</small>	<u>07:00 AM</u> <small>(Specify AM or PM)</small>
<b>ANALYSES COMPLETED:</b>	<b>DATE:</b>	<b>TIME:</b>
	<u>01/02/05</u> <small>(MM/DD/YY)</small>	<u>07:00 AM</u> <small>(Specify AM or PM)</small>

Laboratory Log #: 18808

Certified By: *Jessie Hicks*  
(Print and sign name)

COMMENTS: \_\_\_\_\_

REPORT # 4-8499

# EMSL Analytical, Inc.

231 Longview Dr.  
Kannonsville, NC 27284  
(336) 992-1025



## ASBESTOS ANALYSIS

Note: All information must be supplied for compliance credit.

Page 9 of 12

WATER SYSTEM ID #: N/A

County: Dare

Name of Water System:

Sample Type:  Distribution  Entry Point  Special/Non-compliance

Location Where Collected: Well #15

Location Code:         

Collection Date	Collection Time
<u>12/21/04</u> <small>(MM/DD/YYYY)</small>	<u>07:25 AM</u> <small>(Specify AM or PM)</small>

Collected By: K. Schultes  
(Please Print)

Mail Results to (water system representative):

Environmental Chemists

6602 Windmill Way

Wilmington, NC 28405

Phone #: (910) 392-0223

Fax #: (910) 392-4424

LABORATORY ID #: 3 7 7 6 6

SAMPLE UNSATISFACTORY

RESAMPLE REQUIRED

CONTAM CODE	CONTAMINANT	METHOD CODE	REQUIRED REPORTING LIMIT (R.R.L.)	NOT DETECTED (i.e. < R.R.L.) (X)	QUANTIFIED RESULTS <sub>1,2</sub>	ALLOWABLE LIMIT
1791	Chrysotile	<u>1 7 2</u>	0.2 MFL	<input checked="" type="checkbox"/>	MFL	7.0 MFL
1792	Amphibole	<u>1 7 2</u>	0.2 MFL	<input checked="" type="checkbox"/>	MFL	7.0 MFL
1094	Total Asbestos	<u>1 7 2</u>	0.2 MFL	<input checked="" type="checkbox"/>	MFL	7.0 MFL

Notes: <sup>1</sup> MFL = Million Fibers per Liter > 10 µm.

<sup>2</sup> If result exceeds allowable limit, the laboratory must fax analytical results to the State within 48 hours.

	DATE:	TIME:
ANALYSES BEGUN:	<u>01/06/05</u> <small>(MM/DD/YYYY)</small>	<u>04:22 PM</u> <small>(Specify AM or PM)</small>
ANALYSES COMPLETED:	<u>01/06/05</u> <small>(MM/DD/YYYY)</small>	<u>04:27 PM</u> <small>(Specify AM or PM)</small>

Laboratory Log #: 020405185(2)

#18808

Certified By: Joe McOscar

Joseph M. McOscar  
(Print and sign name)

4-8499

COMMENTS: \_\_\_\_\_

07/21/02

Laboratory should Mail Results to:

Public Water Supply Section, Attn: Data Entry, 1634 Mail Service Center, Raleigh, NC 27699-1634  
Fax: 919.715.6637



# Florida Radiochemistry Services, Inc.

Contact: Michael J. Neumann  
5456 E. Hall Ave., Suite 201, Orlando, FL 32812  
Phone (407) 382-7733 Fax (407) 382-7744

Page 10 of 12

## RADIOLOGICAL ANALYSIS

Note: All information must be supplied for complete credit.

WATER SYSTEM ID #: \_\_\_\_\_

Name of Water System: Deke County Well #15

County: Deke Date: \_\_\_\_\_

Sample Type:  Distribution  Entry Point  Composite  Special/Non-compliance

Mail Results to (system representative):

Envirochem

### Collection Data

Period	Date (mm/dd/yyyy)	Time (approx AM or PM)	Loc. Code	Sample Location	Collected By
1 <sup>st</sup> Qtr	12/22/04	7:25 AM	---	Well	KS
2 <sup>nd</sup> Qtr	---	---	M	---	---
3 <sup>rd</sup> Qtr	---	---	M	---	---
4 <sup>th</sup> Qtr	---	---	M	---	---

Telephone #: ( ) \_\_\_\_\_

Fax #: ( ) \_\_\_\_\_

LABORATORY ID #: 12709

SAMPLE UNSATISFACTORY  RESAMPLE REQUIRED

CONTAM CODE	CONTAMINANT	METHOD CODE	REQUIRED REPORTING LIMIT (R.R.L.)	NET DETECTED (As < R.R.L.) (D)	QUANTIFIED RESULTS <sup>a</sup>	COUNTING BRACK	ALLOWABLE LIMIT
4000	Gross Alpha ✓	435	3 pCi/L	<input type="checkbox"/>	5.2 pCi/L	5.9	15 pCi/L
4004	Radon	N/A	100 pCi/L	<input type="checkbox"/>	---	---	N/A
4006	Uranium ✓	456	2 pCi/L	<input type="checkbox"/>	4.3 pCi/L	7.3	20.1 pCi/L
4010	Combined Radium	N/A	N/A	N/A	---	---	5 pCi/L
4020	Radium 226 ✓	446	1 pCi/L	<input checked="" type="checkbox"/>	---	0.7	3 pCi/L
4030	Radium 228 ✓	452	1 pCi/L	<input checked="" type="checkbox"/>	---	0.6	2 pCi/L
4100	Gross Beta ✓	435	4 pCi/L	<input type="checkbox"/>	32.0 pCi/L	6.5	50 pCi/L
4102	Tritium	N/A	1,000 pCi/L	<input type="checkbox"/>	---	---	20,000 pCi/L
4172	Strontium 89	N/A	10 pCi/L	<input type="checkbox"/>	---	---	N/A
4174	Strontium 90	425	2 pCi/L	<input type="checkbox"/>	---	---	8 pCi/L
4264	Iodine 131	N/A	1 pCi/L	<input type="checkbox"/>	---	---	N/A
4270	Cesium 134	N/A	10 pCi/L	<input type="checkbox"/>	---	---	N/A

\*Note: If result exceeds allowable limit, the laboratory must fax analytical results to the State within 48 hours.

DATE:

TIME:

ANALYSES BEGUN:

01/13/05

08:57 AM

ANALYSES COMPLETED:

02/03/05

02:22 AM

Laboratory Log #: 0501064-04

ID#18808

Certified By: MIKE NEUMANN/mjneumann  
(Print and Sign Name)

COMMENTS:

12-31-03

REPORT # 4-8499



Analytical & Consulting Chemists

Environmental Chemists, Inc.
6602 Windmill Way • Wilmington, North Carolina 28405
(910) 392-0223 Phone • (910) 392-4424 Fax
EChemW@aol.com
NCDENR: DWQ Certificate #94, DLS Certificate #37729

BACTERIOLOGICAL ANALYSIS

Note: All appropriate information must be supplied for compliance credit.

Page 11 of 12

Water System ID#: \_\_\_\_\_

County: Dare

Name of Water System: A.C. Schultes

Sample Type: [ ] Routine distribution [ ] Repeat [ ] Plan Review [ ] Special/Non-compliance

Location Where Collected: Dare Co. Well #15

(Note: sample MUST be collected from distribution system for routine compliance, not the well house.)

Location Code: \_\_\_\_\_

Collected By: Kevin Schultes

Collection Date: 12/22/04 Collection Time: 7:35 AM

Mail Results to (water system representative):
A.C. Schultes
3887 S. NC 41
Wallace, NC 28466

Also Complete for REPEAT Samples:
Previous Positive Location Code: \_\_\_\_\_
Previous Collection Date: \_\_\_\_\_/\_\_\_\_\_/\_\_\_\_
Proximity of THIS sample to Previous Positive:
[ ] Same Tap [ ] Nearer to the Source [ ] Further from the Source

Phone No.: \_\_\_\_\_
Fax No.: \_\_\_\_\_
Responsible Person's Email: \_\_\_\_\_

If Chlorinated: Total Chlorine Residual: \_\_\_\_\_ mg/L
Free Chlorine Residual: \_\_\_\_\_ mg/L
Combined Chlorine Residual: \_\_\_\_\_ mg/L
(Combined Chlorine = total Chlorine minus Free Chlorine)
Note: Also record these values on your water usage report.

Laboratory ID#: 37729

[ ] Repeat Samples Required from Client
[ ] Resample required from Client

Table with columns: CONTAMINANT, METHOD CODE, PRESENT, RESULTS (ABSENT), INVALID CODE #. Rows include Total Coliform, Fecal/E. Coli, and Heterotrophic P.C.

- INVALID CODES
1) Confluent Growth/No Coliform Growth Found
2) TBTC/No coliform Growth Found
3) Turbid Culture/No coliform Growth Found
4) Over 30 Hours Old
5) Improper sample or Analysis

Notes: 1 If Total coliform Bacteria is present, the laboratory must fax analytical results to the State within 48 hours.
2 If Fecal/E. Coli bacteria is present, the laboratory must fax analytical results to the State on day test completed.
3 Invalid samples (code #5) should be accompanied by an explanation in the comments below.

Table with columns: DATE, TIME. Rows: Analysis Begun (12/22/04, 1:00 PM), Analysis Completed (12/23/04, 1:00 PM)

Laboratory Log #: 18808

Certified By: P. Highland / P. Highland
(Print and Sign Name)

COMMENTS:

Bottle ID # TURBIDITY: Report # 4-8499

